



# C-316 SERIES



## THE C-316 SERIES

General Description.....	Page 3
Specifications.....	Page 4
Repair kits.....	Page 3
Cross Reference Chart.....	Page 5
Recommended Hazardous Location Solenoid Option Packages.....	Page 5

## THE C-316 Side Ported

<b>Solenoid Operated</b>	
Solenoid Operated.....	Page 8
Solenoid, Palm button,.....	Page 9
Solenoid Latching.....	Page 11
Electrical.....	Page 7 - 8
<b>Pilot Operated</b>	
Pilot Operated.....	Page 9
Pilot, Palm button,.....	Page 9 - 10
Pilot Latching.....	Page 10 - 11
<b>Manually Operated</b>	
Manual Palm Button.....	Page 13- 14
Rotary.....	Page 14
Key.....	Page 15
Lock Out.....	Page 16
By Pass.....	Page 16
<b>Mechanical</b>	
CAM.....	Page 17



## THE C-316 NAMUR

<b>NAMUR – Direct Mount</b>	
Solenoid Operated.....	Page 18
Latching.....	Page 18



## CMAP

<b>CMAP – Modular Air Package</b>	
Solenoid Operated.....	Page 19
Latching.....	Page 19



## Options

Solenoid Manual Override.....	Page 17
Solenoid Vent Options.....	Page 17
Stainless Steel Tag.....	Page 17



# THE C-316 SERIES

## GENERAL DESCRIPTION

### Series “C-316”

The C-316 Series consists of 3-Way 3/2 and 4-Way 5/2 investment cast, 316 stainless steel valves, in three categories: Side Ported, NAMUR style direct mount and CMAP, an integral stainless steel regulator and valve.

#### “C-316” Body Ported Valves

The C-316 Series is available as either a 4-way, for double acting devices or a 3-way, for spring return devices. The 3-way function can be specified as either normally closed or opened.

All solenoid actuators are solenoid/pilot type, which allows the use of the smallest solenoids available resulting in low power consumption. This design also assures a positive shifting force which makes certain the valve shifts when energized and reduces the chance of coil burnout. Single solenoid spring return models utilize an air assisted spring return feature assuring a positive return. Double solenoid models are equipped with a detent that maintains the valve in the last shifted position, even in high vibration environments.

A complete selection of electrical connections, power requirements and area classifications are available. See page 18 & 19.

#### “C-316” Namur Valves

The Versa C-316 Series stainless steel NAMUR mount actuator control valve is a high flow, bubble-tight, 5-port, Pilot valve. It is designed to mount directly to any NAMUR actuator, thus reducing actuator response time and space.

Installed costs are also lower as the need for tubing, fittings, brackets and assembly labor are greatly reduced. All mounting screws and seals are included with valve.

The 5-port design allows the C-316 NAMUR to be ordered as either a 4-way, for double acting actuators or a 3-way, for spring return actuators. When the 3-way function is utilized, the unused exhaust port becomes an actuator vent where a filter/ muffler can be installed to prevent contaminants from entering either the valve or the actuator.

The 5-port design allows the user to independently control actuator speed in either the open or close direction. Speed or bleed controls are optional. See page 16.

#### CMAP Modular Air Package

A CMAP system consists of a filter/regulator, gauge and directional control valve all in one.

CMAP is based on Versa’s field proven C-316 and AR Series. All inter-component connections utilize “O”-ring interface sealing reducing potential leakage points. The combination of C-316 & AR reliability, “O” ring sealing and a simple design principal all provide a reliable and easily maintained product. CMAP is the sensible choice.

The basic CMAP system is made of two configurable modules. Module one is the air preparation module consisting of filter/regulators, gauges and drains. Module two is the control valve module consisting of many different variations of 3-way control valves. See page 17.

### CONSTRUCTION:

#### Balanced Spool

The forces required to actuate the plunger are unaffected by pressures being controlled assuring positive shifting throughout the entire range.

#### Wafer Sealing

Wafer type elastomer sealing provides leakproof operation throughout entire pressure range. The wafer/wiper style seal also provides a low friction profile.

#### Large Diameter Pilot

Large diameter pilot piston produces high shifting forces in Versa C-316 pilot and Solenoid actuated applications assuring a positive shifting force. The U cup offers friction free sealing for a positive shift.

#### Epoxy Molded Coil

Epoxy molding offers moisture resistance and heat dissipation in the toughest applications.

#### Air-Assisted Spring Return

Air boosts spring for positive valve return.

#### Investment Cast Stainless Steel

316 stainless steel components utilized for superior corrosion protection in the harshest environments. Investment cast components offer a first class finish while providing weight savings and superior flow.

#### Fully Ported – High Flow

Internal flow area equal to or greater than the area of the corresponding pipe/tube size.

#### High Performance Solenoid Actuator

All the C-316 Series solenoid valves utilize a high performance solenoid pilot design. This design utilizes available media pressure/force to shift valve assuring positive shifting. This design also produces the lowest wattage requirements in the industry.

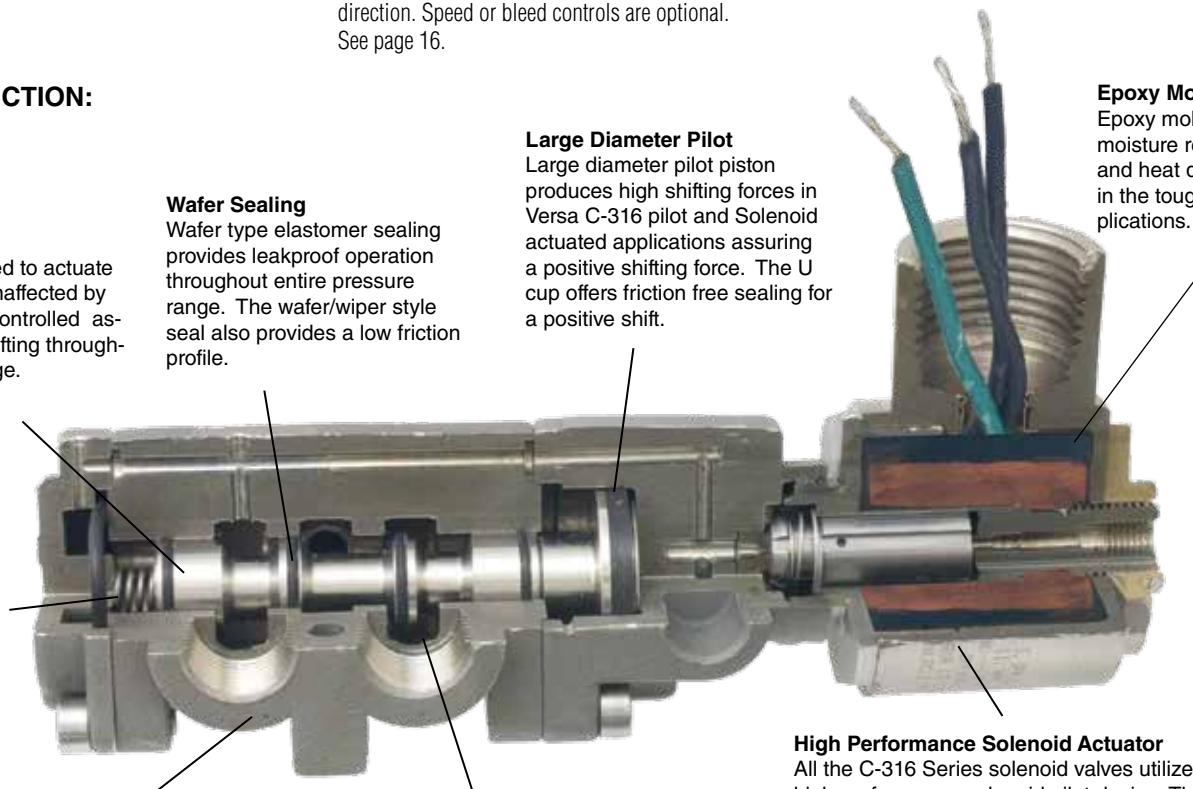

# THE C-316 SERIES

## Specifications

<b>Flow Rate:</b>	Cv = 2.0
NAMUR	Cv = 1.6
CMAP	Cv = 1.5
<b>Port Size:</b>	Inlet, cylinder and exhaust: 1/4" NPT
<b>Media:</b> C-316	Pneumatic*
CMAP	Pneumatic
<b>Pilot:</b>	Inpilot & Exipilot solenoid valves
<b>Temperature:</b>	-5 to 200°F (-20 to 93° C), Media and ambient
Low Temp (-44 option) Manual:	-20 to 200°F (-29 to 93°C), Media and ambient
Pilot:	-55 to 200°F (-48 to 93°C), Media and ambient
Solenoid:	-40 (-40°C) to Max based on solenoid type

\*For hydraulic service consult factory

Operating Pressure		
Valve Function	Minimum psi (bar)	Maximum psi (bar)
Single Solenoid Spring Return	25 (1.8)	150* (10.3)
Dual Solenoid Detent	15 (1.0)	150* (10.3)
Exipilot Spring Return (with and without strong spring -S)	See Controlled (inlet) Pressure chart below	

\*Exhaust restriction recommended for operating pressures over 125 psi (8.6 bar)

Pilot Operated Spring Return	Controlled (inlet) Pressure															
	psi		bar		psi		bar		psi		bar		psi		bar	
	25	1.7	30	1.2	50	3.4	70	4.8	90	6.2	110	7.6	130	9.0	150	10.3
Minimum Pilot Pressure Required	19	1.3	20	1.4	27	1.9	33	2.3	40	2.8	46	3.2	52	3.6	59	4.1

<b>Materials:</b>	
<b>Valve body and internal parts:</b>	316L stainless steel
<b>Actuator caps:</b>	316L stainless steel
<b>Valve seals:</b>	FKM (fluorocarbon)
Option	Low Temp Nitrile ("44")
<b>Screws:</b>	Stainless steel
<b>Solenoid internal parts:</b>	304, 430F and 302 stainless steel
<b>Solenoid Coil housing:</b>	Depends on coil selected, see page 19

Repair kits		Repair Kit Number		
Prefix No.	Suffix No.	3-Way	4-Way	NAMUR
CAG, CGA CAP, CPA	136PE	C-3301-316-356AN	C-4302-316-356AN	*
CZA, CAZ	314E 357E	C-3301-316-AZ	C-4302-316-AZ	*
CSI, CIS CSA, CAS	Standard 357E	C-3301-316-S	C-4302-316-S	*
CSC, CCS CAI, CIA	Standard 150E			
CZI, CIZ CAI, CIA	Standard 173E	C-3301-316-ZI	C-4302-316-ZI	*
CAG, CGA CAG, CGA	356B 356BN	C-3321-316-356AN C-3321-316-356BN	C-4322-316-356AN C-4322-316-356BN	*
CAP, CPA CGG, CPP	Standard	C-3321-316-GG C-3321-316-SG	C-4322-316-GG C-4322-316-SP	C-4322-316-GG-NE *
CSP, CPS CSG, CGS	Standard	C-3321-316-SG	C-4322-316-SP	C-4322-316-SG-NE
CAP, CPA CSA, CAS	314E 314E	C-3301-316-AP C-3301-316-SI	C-4302-316-AP C-4302-316-SI	*
CIZ	LOV	C-3301-316-ZI-LOV	C-4302-316-ZI-LOV	*

\*For NAMUR valve repair kits contact factory.

## SELECTOR CHART & PRODUCT NUMBERING

Each letter and digit in the product number of a Versa Valve has a significant meaning, as explained below.

Valve Series	S		G	3	3	2	1	316	XX		A120									
	ACTUATING DEVICES								Function			Port Size		Type of Body		Spool Details (flow pattern)		Material	Suffix Details	
	Left Side*	Right Side*							(see Spool Details)							Mechanical	Electrical			
Series C-316 Valves	<b>A Combination Actuators</b> 136PE, -150E, -173E, -314E, -356B, -356BN, -357E <b>see suffix column</b>		2* Two-Way 2/2 3 Three-Way 3/2 4 Four-Way 5/2	3 1/4" NPT	0 Exipilot Body with threaded side-ports (for Manual, Pilot and Exipilot solenoid actuated valves)  2 Inpilot Body with threaded side-ports with internal drilling to supply inlet pressure to Solenoid-pilot actuator  3 Inpilot Manifold mounted with internal drilling to supply inlet pressure to Solenoid-pilot actuator. NAMUR Valve	Three-Way 3/2 Valves 1 Normally Closed 2 Normally Open  Four-Way 5/2 Valves 2 2-Position	'316' indicates that the basic construction material for valve parts is AISI 316 Stainless Steel (Conforms to NACE Standard MR-01-75)	-CA3 CMAP identifier -NE_ NAMUR valve with 316 mounting screws, -NE1 10-28 -NE2 10-32 -NE3 M5 -DG Dust Proof -44 Low Temperature seals -U Up Right coil housing -ME Override, momentary contact <b>Page 15</b>  <b>Tagging</b> -NV28A, Stainless steel ID tag; see <b>Page 15</b>  <b>Combination Actuators</b> -136PE Palm Button, Spring Return <b>Page 6 &amp; 8</b> -150E Pilot-2-Position Detent <b>Page 9</b> -173E Solenoid, 2-Position Detent <b>Page 6</b> -314E Key Operated Actuator <b>Page 12-13</b> -356B Button Actuator W/ Latch - Reset <b>Page 7</b> -356BN Actuator W/ Latch - Reset No Button <b>Page 7, 9 &amp; 16</b> -357E Rotary Switch-2-Position Detent <b>Page 11-12</b>	<b>Electrical</b> -HT High Temp coil -LA 0.85 Watt coil -LB 1.8 Watt coil -PC NEMA 4/4X -ST Stainless steel coil housing -U Upright solenoid end cap -XDB_ Stainless Steel housing, multi agency approvals -XX NEMA 7 & 9 -XN ATEX <b>See page 18</b> for Suffix specifications  <b>Rating Code:</b> A= 60Hz frequency D= Direct Current (DC) E= 50Hz frequency Three numbers follow the Rating Code to indicate voltage:  <b>Examples:</b> <table border="1"> <tr> <th>Voltage</th> <th>Code</th> </tr> <tr> <td>24V60 =</td> <td>024</td> </tr> <tr> <td>120V60 =</td> <td>120</td> </tr> <tr> <td>24VDC =</td> <td>024</td> </tr> </table>	Voltage	Code	24V60 =	024	120V60 =	120	24VDC =	024			
Voltage	Code																			
24V60 =	024																			
120V60 =	120																			
24VDC =	024																			
	*NOTE "S" above is on left end of valve looking at inlet "G" above is on right end of valve looking at inlet																			

# THE C-316 SERIES

## Hazardous Location Combination Suffix Details Cross Reference Chart

Suffix Reference	
Suffix	Description
-XX	North American solenoid
-XN	ATEX solenoid
-XDB	World Solenoid
-HT	Class H coil
-ST	Stainless solenoid housing
-PC	Potted coil
-LB	1.8 watt solenoid
-LA	0.85 watt solenoid
-VJBT	Add on Junction Box
-D14	Solenoid vent, water proof nut
-PS	Potted coil, male conduit
-CD	72" wire leads
-LX	1.8 watt solenoid
-H2E	1/8" npt solenoid vent
-HE	1/4" npt solenoid vent
-L14	solenoid vent dust nut
-303D	Integral diode

North American (-XX)	
Combination Suffix	Included Suffix
-XXA	-XX, -HT
-XXA4	-XX, -D14, -HT
-XXB	-XX, -PS
-XXB4	-XX, -D14, -PS
-XXC	-XX, -HT, -PS
-XXC4	-XX, -D14, -HT, -PS
-XXD	-XX, -ST
-XXD4	-XX, -D14, -ST
-XXE	-XX, -PC, -ST
-XXE4	-XX, -D14, -PC, -ST
-XXF	-XX, -HT, -ST
-XXF4	-XX, -D14, -HT, -ST
-XXG	-XX, -LB, -ST
-XXG4	-XX, -D14, -LB, -ST
-XXH	-XX, -HT, -PC, -ST
-XXJ	-XX, -LB, -PC, -ST
-XXJ4	-XX, -D14, -LB, -PC, -ST

North American (-XX) (Cont.)	
Combination Suffix	Included Suffix
-XXX	-XX, -HT, -LB, -PC, -ST
-XXX4	-XX, -D14, -HT, -LB, -PC, -ST
-XXL	-XX, -PC
-XXL4	-XX, -D14, -PC
-XXM	-XX, -HT, -PC
-XXM4	-XX, -D14, -HT, -PC
-XXN	-XX, -LB, -PC
-XXN4	-XX, -D14, -LB, -PC
-XXP	-XX, -HT, -LB, -PC
-XXP4	-XX, -D14, -HT, -LB, -PC
-XXQ	-XX, -HT, -LB
-XXQ4	-XX, -D14, -HT, -LB
-XXR	-XX, -LB
-XXR4	-XX, -D14, -LB
-XXS	-XX, -LA, -ST
-XXS4	-XX, -D14, -LA, -ST
-XXU	-XX, -HT, -LB, -ST
-XXU4	-XX, -D14, -HT, -LB, -ST
-XXV	-XX, -LA
-XXV4	-XX, -D14, -LA
-XXW	-XX, -CD, -HT, -H2, -PC, -ST
-XXW4	-XX, -D14, -CD, -HT, -PC, -ST

ATEX (XN)	
Combination Suffix	Included Suffix
-XNA	-XN, -HT
-XND	-XN, -ST
-XNE	-XN, -PC, -ST
-XNE4	-XN, -D14, -PC, -ST
-XNF	-XN, -HT, -ST
-XNG	-XN, -LB, -ST
-XNH	-XN, -HT, -PC, -ST
-XNJ	-XN, -LB, -PC, -ST
-XNJ4	-XN, -D14, -LB, -PC, -ST
-XNK	-XN, -HT, -LB, -PC, -ST
-XXK4	-XN, -D14, -HT, -LB, -PC, -ST
-XNL	-XN, -PC

ATEX (XN) (Cont.)	
Combination Suffix	Included Suffix
-XNL4	-XN, -D14, -PC
-XNM	-XN, -HT, -PC
-XNN	-XN, -LB, -PC
-XNN4	-XN, -D14, -LB, -PC
-XNP	-XN, -HT, -LB, -PC
-XNQ	-XN, -HT, -LB
-XNR	-XN, -LB
-XNS	-XN, -LA, -ST
-XNS4	-XN, -D14, -LA, -ST
-XNU	-XN, -HT, -LB, -ST
-XNV	-XN, -LA
-XNV4	-XN, -D14, -LA
-XNX	-XN, -LB, -PS
-XNWS	-XN, -VJBT, -LB, -PS

World Solenoid (XDB)	
Combination Suffix	Included Suffix
-XDBS1	-XDBS, -HT, -LX
-XDBS2	-XDBS, -HT, -LX, -H2E
-XDBS3	-XDBS, -HT, -LX, -HE
-XDBS4	-XDBS, -HT, -LX, -L14
-XDBS5	-XDBS, -HT, -LX, -303D
-XDBS6	-XDBS, -HT, -LX, -H2E, -303D
-XDBS7	-XDBS, -HT, -LX, -HE, -303D
-XDBS8	-XDBS, -HT, -LX, -L14, -303D
-XDBS9	-XDBS, -HT, -LX, -D14
-XDBS10	-XDBS, -HT, -LX, -D14, -303D
-XDBT1	-XDBT, -HT, -LX
-XDBT2	-XDBT, -HT, -LX, -H2E
-XDBT3	-XDBT, -HT, -LX, -HE
-XDBT4	-XDBT, -HT, -LX, -L14
-XDBT5	-XDBT, -HT, -LX, -303D
-XDBT6	-XDBT, -HT, -LX, -H2E, -303D
-XDBT7	-XDBT, -HT, -LX, -HE, -303D
-XDBT8	-XDBT, -HT, -LX, -L14, -303D
-XDBT9	-XDBT, -HT, -LX, -D14
-XDBT10	-XDBT, -HT, -LX, -D14, -303D

## Recommended Hazardous Location Solenoid Option Packages

(For complete specifications please see above and page 5)



Enclosure/Wire	Certification/Power			
	North American - CSA		ATEX - IECEx - INMETRO	
	Standard Power	Low Watt*	Standard Power	Low Watt*
Steel, Electroless Nickel Plated, 24 Inch Leads	-XXL4	-XXN4	-XNL4	-XNN4
Stainless Steel, High Performance 430 type, 24" wire leads	-XXE4	-XXJ4	-XNE4	-XNJ4
Stainless Steel, 316L type, Junction Box with Terminal Strip	n/a	-XDBT9**	n/a	-XDBS9

\* 1.8 watt solenoid. Also available is 0.85 watt, see cross reference chart above. For 0.50 watt, consult factory.

\*\* All the -XDBT type solenoids are "World Solenoids." Certified for North America, ATEX, IECEx and INMETRO

# Electrical

## NON HAZARDOUS LOCATIONS OPERATORS

	Suffix Identification	Protection Classification	Area Classification and (Gas Grouping)	Certification-(Conformance)	Ingress Protection
	None or -HT, PC	General Purpose	Indoor & Outdoor	CSA	NEMA 1,2, 3 & 4
	-HC -HCC (Shown)	General Purpose	Indoor & Outdoor	CSA	NEMA 4; IP65

## HAZARDOUS LOCATION OPERATORS

	Suffix Identification	Protection Classification	Area Classification and (Gas Grouping)	Certification-(Conformance)	Ingress Protection
	-XX -LB-XX	Hazardous Locations	CLASS I, DIV. 2 (A & B) CLASS I, DIV. 1 (C & D) CLASS II, DIV. 1 (E, F & G)	UL - CSA	NEMA 7 & 9
See page 4 for recommended options					
	-XN -LB-XN	(d) Flameproof	Ex d IIB+H2 T3 to T6 Gb II 2 G Ex d IIB+H2 T3 to T6	IECEX	P65 & IP66
See page 4 for recommended options				IECEX ATEX	
	-XDBS* -XDBT*	(d) Flameproof (e) Increased Safety	EX II 2 G D Ex d e IIC T* Gb EX tb IIIC T* °C Db Class I Div I Grp B, C & D Class I Div II Grp E, F & G EX d IIC DIP A21 T6 T4	ATEX IECEX -INMETRO CSA	IP66, IP67, & IP68
See page 4 for recommended options					
	-XMAA -XMAE -XMAF -XMAG -XMFA -XMFE -XMFF -XMFG	(mb) Encapsulation (e) Increased Safety (tD) Tight Dust	Ex e mb II T5, T6 Gb Ex tD A21 T100°C, T85°C Db II 2 G Ex e mb II T5, T6 II 2D Ex tD A21 T100°C, T85°C	IECEX	IP66 & IP67
				ATEX	
	-XIFA -XIFE -XIFF	(ia) Intrinsic Safe	Ex (ia) IIC T4...T6 Gb Ex (ia) IIIC T130°C, T80°C Db II 2 G Ex ia IIC T4...T6 II 2 D Ex iaD 21 T130°C, T80°C	IECEX	IP66 & IP67
				ATEX	
	-XISX6 -XISC	Intrinsic Safe	II 2 G EEx ia IIC T6 Class I, Groups (A, B, C & D) Class II, Groups (E, F, & G) Class III	ATEX Factory Mutual CSA	IP65

\* -U (up right coil cap) Recommended for use with -XDB\_, -XMA\_, -XMF\_ & XIF\_ coils on NAMUR valves for mounting clearance. See page 5 for dimensions.

PRODUCT NUMBER COIL CODES: Complete product numbers require, when applicable, a coil code that represents the desired coil current type, frequency and voltage. The coil code takes the form shown below, with ratings and voltage substituted as required.

Rating Code                      Voltage  
 A = 60Hz frequency            Indicated by three digits:  
 D = Direct Current (DC)        e.g. 24 volts = 024  
 E = 50Hz frequency            120 volts = 120.  
 A120 = AC, 120Volts/60hz

Voltage (Power)	Electrical Characteristics	Miscellaneous																																	
All usual 50 Hz & 60 Hz AC (6W) All usual DC (7W)	Class F epoxy molded coil (155°C). Continuous duty, 2 leads 24" (60 cm).	Steel cover with 1/2 NPT conduit entry.																																	
24V60, 120V60, 240V60 (8.5W) 24V50, 110V50, 220V50 (8.5W) 12VDC, 24VDC, 48VDC (10.5W)	Class F epoxy molded coil (155°C), with 3 spade terminals. Continuous duty.	Mini DIN socket with PG9 cable gland (-HC) or 1/2" conduit connection (-HCC).																																	
Voltage (Power)	Electrical Characteristics	Miscellaneous																																	
All usual 50 Hz & 60 Hz AC (5.6W) All usual DC (7.2W)	Class F epoxy molded coil (155°C). Continuous duty. 3 leads 24" (60 cm).	Steel, Electroless Nickel plated coil housing with 1/2 NPT conduit entry. For stainless steel (182FM) coil housing add: (-ST)																																	
12V60, 24V60, 48V60, 120V60, 240V60 (1.8W) 6VDC, 12VDC, 24VDC, 48VDC (1.8W)		Steel, Electroless Nickel plated coil housing with 1/2 NPT conduit entry. For stainless steel (182FM) coil housing add: (-ST) Maximum pilot pressure 120 psi (8 bar). 1.8W nominal power.																																	
All usual 50 Hz & 60 Hz AC (5.6W) All usual DC (7.2W)		Steel, Electroless Nickel plated coil housing with M20 x 1.5 conduit entry. Ground terminal on cover. For stainless steel (182FM) coil housing add: (-ST)																																	
12V60, 24V60, 48V60, 120V60, 240V60 (1.8W) 6VDC, 12VDC, 24VDC, 48VDC (1.8W)		Steel, Electroless Nickel plated coil housing with M20 x 1.5 conduit entry. Ground terminal on cover. For stainless steel (182FM) coil housing add: (-ST) Maximum pilot pressure 120 psi (8 bar) 1.8W nominal power.																																	
24VDC (D024) 120V60 (A120) 110V50 (E110) 230V50 (E230)  1.8 Watt standard, for lower watt contact factory.	Epoxy molded coils rated for continuous duty, Class H, 180°C.	<table border="1"> <thead> <tr> <th rowspan="3">Stainless steel coil housing with internal Junction Box. Internal and external ground screw.</th> <th colspan="4">Suffix Detail Ordering Code</th> </tr> <tr> <th colspan="2">M 20 Connection</th> <th colspan="2">1/2" Connection</th> </tr> <tr> <th>No Diode</th> <th>Diode</th> <th>No Diode</th> <th>Diode</th> </tr> </thead> <tbody> <tr> <td>Standard (vent to atmosphere)</td> <td>XDBS1</td> <td>XDBS5</td> <td>XDBT1</td> <td>XDBT5</td> </tr> <tr> <td>1/8" Adapter (-H2E)</td> <td>XDBS2</td> <td>XDBS6</td> <td>XDBT2</td> <td>XDBT6</td> </tr> <tr> <td>1/4" Adapter (-HE)</td> <td>XDBS3</td> <td>XDBS7</td> <td>XDBT3</td> <td>XDBT7</td> </tr> <tr> <td>Dust Nut (-L14)</td> <td>XDBS4</td> <td>XDBS8</td> <td>XDBT4</td> <td>XDBT8</td> </tr> </tbody> </table>	Stainless steel coil housing with internal Junction Box. Internal and external ground screw.	Suffix Detail Ordering Code				M 20 Connection		1/2" Connection		No Diode	Diode	No Diode	Diode	Standard (vent to atmosphere)	XDBS1	XDBS5	XDBT1	XDBT5	1/8" Adapter (-H2E)	XDBS2	XDBS6	XDBT2	XDBT6	1/4" Adapter (-HE)	XDBS3	XDBS7	XDBT3	XDBT7	Dust Nut (-L14)	XDBS4	XDBS8	XDBT4	XDBT8
		Stainless steel coil housing with internal Junction Box. Internal and external ground screw.		Suffix Detail Ordering Code																															
				M 20 Connection		1/2" Connection																													
			No Diode	Diode	No Diode	Diode																													
		Standard (vent to atmosphere)	XDBS1	XDBS5	XDBT1	XDBT5																													
1/8" Adapter (-H2E)	XDBS2	XDBS6	XDBT2	XDBT6																															
1/4" Adapter (-HE)	XDBS3	XDBS7	XDBT3	XDBT7																															
Dust Nut (-L14)	XDBS4	XDBS8	XDBT4	XDBT8																															
24VDC (4W) (Consult factory for other voltage options)	Continuous duty. Coil & rectifier, including surge suppression, potted within housing.	Thick wall epoxy coil housing with integral junction box. Internal ground terminal. M20 x 1.5 conduit entry: (-XMAA), (-XMFA), Cable gland for 6-12 mm ø cable: (-XMAE), (-XMFE) 1/2 NPT conduit entry with adapter: (-XMAF), (-XMFF) Cable gland for 9-16 mm ø cable: (-XMAG), (-XMFG)																																	
24VDC (10W inrush, 4 W holding) (Consult factory for other voltages)	Continuous duty. Coil & power controller potted with in housing.																																		
24VDC (0.8W) (Consult factory for other voltages)	Continuous duty. Coil and power controller potted within housing.	Requires the use of an approved safety barrier or isolator. Thick wall epoxy coil housing and integral junction box. Internal ground terminal. M20 x 1.5 conduit entry: (-XIFA) Cable gland for 6-12 mm ø cable: (-XIFE) 1/2 NPT conduit entry with adapter: (-XIFF)																																	
24VDC system voltage prior to barrier (1.6 watt max.)	Class F epoxy molded coil (155°C). Continuous duty.	Requires the use of an approved barrier or isolator. Maximum operating system voltage before barrier 28VDC. Maximum pilot pressure 115 psi (8 bar). 3 spade terminals & DIN connector with PG9 cable gland: (-HC) 1/2 NPT conduit entry: (-HCC)																																	

# THE C-316 SERIES

## Mounting Hole Dimensions Side Ported Valves

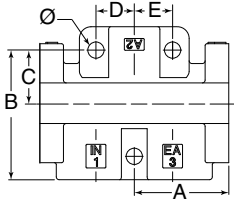

Mounting Hole Dimensions	A	A	B	C	D	E	Ø
	3-Way	4-Way					
Inches	1.0	1.25	1.13	0.56	0.41	0.41	0.17
mm	25.4	31.8	28.6	14.3	10.3	10.3	4.4

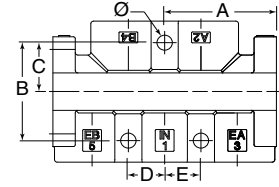

## Optional Upright Coil Housing

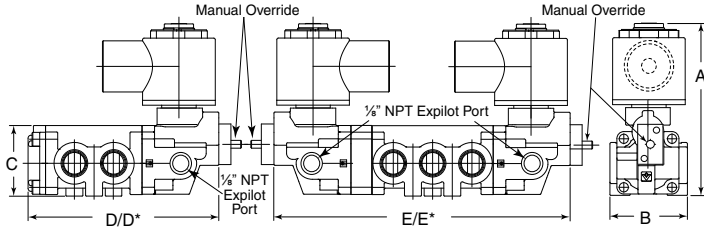

Available as an option on side ported valves.

Recommended for use with -XDB\_, -XMA\_, -XMF\_ & XIF\_ coils on NAMUR valves for mounting clearance.

Solenoid shown is hazardous location type -XX. For more options see page 18.

	A	B	C	D	D*	E	E*
<b>Side Ported</b>							
Inches	2.8	1.62	1.42	5.41	5.91	8.53	9.0
mm	72.1	41.1	36.1	137.5	150.1	217	288.6
<b>NAMUR</b>							
Inches	2.8	1.63	1.44	4.14	4.14	7.25	7.25
mm	72.1	41.3	36.6	105.2	105.2	184.2	184.2

## Body Ported Valves

### SOLENOID OPERATED

Side Ported	Function	Actuation	Pilot Type	Part Number	Weight	Flow Symbol
	3-Way 2-Position Normally Closed 3/2	Single Solenoid Spring Return	Inpilot	CSG-3321-316-(*)	1.6 lbs 0.7 kg	
			Expiport	CSG-3301-316-(*)		
	3-Way 2-Position- Normally Open 3/2	Single Solenoid Spring Return	Inpilot	CGS-3322-316-(*)	1.6 lbs 0.7 kg	
			Expiport	CGS-3302-316-(*)		
	3-Way 2-Position 3/2	Double Solenoid Detent	Inpilot	CGG-3321-316-(*)	2.5 lbs 1.1 kg	
			Expiport	CGG-3301-316-(*)		
	4-Way 2-Position 5/2	Single Solenoid Spring Return	Inpilot	CSG-4322-316-(*)	1.7 lbs 0.8 kg	
			Expiport	CSG-4302-316-(*)		
	4-Way 2-Position 5/2	Double Solenoid Detent	Inpilot	CGG-4322-316-(*)	2.6 lbs 1.2 kg	
			Expiport	CGG-4302-316-(*)		

\* Add solenoid/coil voltages (page 19) & Suffix from Selector Chart (page 3)

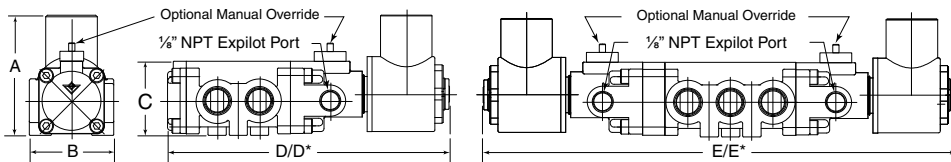

Solenoid shown is hazardous location type -XX. For more options see page 18.

	A	B	C	D	D*	E	E*
Inches	2.8	1.62	1.42	5.41	5.91	8.53	9.0
mm	72.1	41.1	10.3	137.5	150.1	217	288.6



# THE C-316 SERIES

## Body Ported Valves

### SOLENOID, PALM BUTTON with SPRING RETURN

Side Ported	Function	Actuation	Pilot Type	Part Number	Weight	Flow Symbol
	3-Way 2-Position Normally Closed 3/2	Single Solenoid Palm Button Spring Return	Inpilot	CAG-3321-316-136PE-(* )	2.0 lbs 0.9 kg	
			Expilot	CAG-3301-316-136PE-(* )		
	3-Way 2-Position Normally Open 3/2	Single Solenoid Palm Button Spring Return	Inpilot	CGA-3322-316-136PE-(* )	2.0 lbs 0.9 kg	
			Expilot	CGA-3302-316-136PE-(* )		
	4-Way 2-Position 5/2	Single Solenoid Palm Button Spring Return	Inpilot	CAG-4322-316-136PE-(* )	2.1 lbs 1.0 kg	
			Expilot	CAG-4302-316-136PE-(* )		

\* Add solenoid/coil voltages (page 19) & Suffix from Selector Chart (page 3)

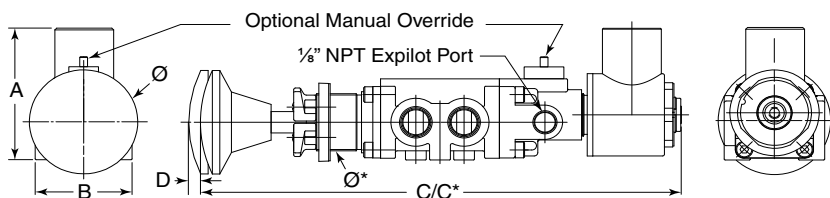

	A	B	C	C*	D	Ø	Ø*
Inches	2.3	1.62	8.08	8.58	.20	1.81	1.0
mm	58.4	41.2	205.2	217.9	5.08	46	25.4

For mounting hole dimensions see page 5

Solenoid shown is hazardous location type -XX. For more options see page 18.  
Manual override see page 15

### SINGLE SOLENOID, PALM BUTTON with DETENT

Side Ported	Function	Actuation	Pilot Type	Part Number	Weight	Flow Symbol
	3-Way 2-Position Normally Closed 3/2	Single Solenoid Detent with Button	Inpilot	CIA-3321-316-173E-(* )	2.1 lbs 1.0 kg	
			Expilot	CIA-3301-316-173E-(* )		
	3-Way 2-Position- Normally Open 3/2	Single Solenoid Detent with Button	Inpilot	CAI-3322-316-173E-(* )	2.1 lbs 1.0 kg	
			Expilot	CAI-3302-316-173E-(* )		
	4-Way 2-Position 5/2	Single Solenoid Detent with Button	Inpilot	CAI-4322-316-173E-(* )	2.2 lbs 1.0 kg	
			Expilot	CAI-4302-316-173E-(* )		

\* Add solenoid/coil voltages (page 19) & Suffix from Selector Chart (page 3)

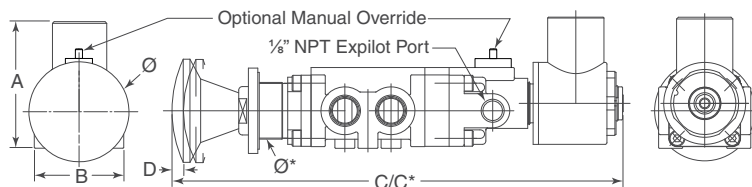

	A	B	C	C*	D	Ø	Ø*
Inches	2.3	1.62	7.92	8.42	.20	1.81	1.0
mm	58.4	41.2	201.2	213.8	5.08	46	25.4

For mounting hole dimensions see page 5

Solenoid shown is hazardous location type -XX. For more options see page 18.  
Manual override see page 15

# THE C-316 SERIES

## Body Ported Valves

### LATCHING, SINGLE SOLENOID, SPRING RETURN without PALM BUTTON

Side Ported	Function	Actuation	Pilot Type	Pilot		Flow Symbol
				Part Number	Weight	
	3-Way 2-Position Normally Closed 3/2	Single Solenoid Spring Return	Inpilot	CAG-3321-316-356BN-(* )	1.9 lbs 0.9 kg	
				Expilot		
	3-Way 2-Position- Normally Open 3/2	Single Solenoid, Latching Reset	Inpilot	CGA-3322-316-356BN-(* )	1.9 lbs 0.9 kg	
				Expilot		
	4-Way 2-Position 5/2	Single Solenoid Latching Reset	Inpilot	CAG-4322-316-356BN-(* )	2.0 lbs 0.9 kg	
				Expilot		

\* Add solenoid/coil voltages (page 19) & Suffix Details from Selector Chart (page 3)

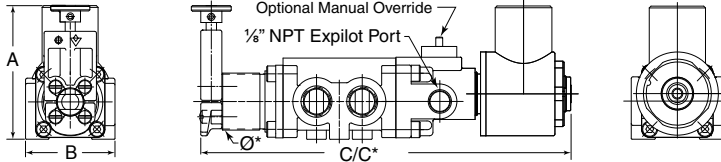

	A	B	C 3-Way	C* 4-Way	Ø*
Inches	2.3	1.62	6.5	7.0	1.0
mm	58.4	41.2	165	177.8	25.4

Solenoid shown is hazardous location type -XX. For more options see page 18.  
Manual override see page 15

For mounting hole dimensions see page 5

### LATCHING, SINGLE SOLENOID, SPRING RETURN with PALM BUTTON

Side Ported	Function	Actuation	Pilot Type	Pilot		Flow Symbol
				Part Number	Weight	
	3-Way 2-Position Normally Closed 3/2	Single Sole- noid, Latching Reset with Button	Inpilot	CAG-3321-316-356B-(* )	2.0 lbs 0.9 kg	
				Expilot		
	3-Way 2-Position- Normally Open 3/2	Single Sole- noid, Latching Reset with Button	Inpilot	CGA-3322-316-356B-(* )	2.0 lbs 0.9 kg	
				Expilot		
	4-Way 2-Position 5/2	Single Sole- noid, Latching Reset with Button	Inpilot	CAG-4322-316-356B-(* )	2.1 lbs 1.0 kg	
				Expilot		

\* Add solenoid/coil voltages (page 19) & Suffix from Selector Chart (page 3)

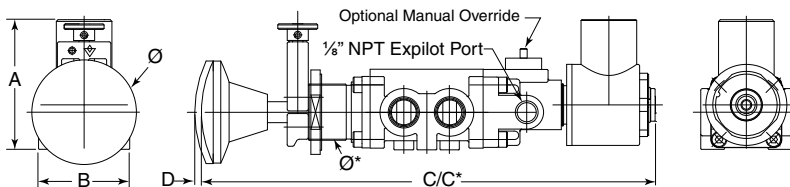

	A	B	C 3-Way	C* 4-Way	D Travel	Ø	Ø*
Inches	2.3	1.62	8.08	8.58	.20	1.81	1.0
mm	58.4	41.2	205.2	217.9	5.08	46	25.4

Solenoid shown is hazardous location type -XX. For more options see page 18.  
Manual override see page 15

For mounting hole dimensions see page 5

# THE C-316 SERIES

## Body Ported Valves

### PILOT OPERATED

Side Ported	Function	Actuation	Pilot Type	Part Number	Weight	Flow Symbol
	3-Way 2-Position Normally Closed 3/2	Single Pilot Spring Return	Remote Pilot	CSP-3301-316	1.0 lbs 0.5 kg	
	3-Way 2-Position- Normally Open 3/2	Single Pilot Spring Return	Remote Pilot	CPS-3302-316	1.0 lbs 0.5 kg	
	3-Way 2-Position 3/2	Double Pilot Detent	Remote Pilot	CPP-3301-316	1.3 lbs 0.6 kg	
	4-Way 2-Position 5/2	Single Pilot Spring Return	Remote Pilot	CSP-4302-316	1.0 lbs 0.5 kg	
	4-Way 2-Position 5/2	Double Pilot Detent	Remote Pilot	CPP-4302-316	1.4 lbs 0.6 kg	

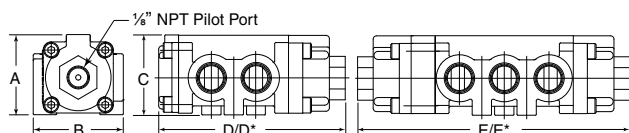

	A	B	C	D	D*	E	E*
	3-Way	4-Way	3-Way	4-Way	3-Way	4-Way	
Inches	2.8	1.62	1.42	3.36	3.86	4.43	4.94
mm	72.1	41.1	10.3	85	98	112.4	125.4

For mounting hole dimensions see page 5

### PILOT, PALM BUTTON with SPRING RETURN

Side Ported	Function	Actuation	Pilot Type	Part Number	Weight	Flow Symbol
	3-Way 2-Position Normally Closed 3/2	Single Pilot Palm Button Spring Return	Remote Pilot	CAP-3301-316-136PE	1.3 lbs 0.6 kg	
	3-Way 2-Position- Normally Open 3/2	Single Pilot Palm Button Spring Return	Remote Pilot	CPA-3302-316-136PE	1.3 lbs 0.6 kg	
	4-Way 2-Position 5/2	Single Pilot Palm Button Spring Return	Remote Pilot	CAP-4302-316-136PE	1.4 lbs 0.6 kg	

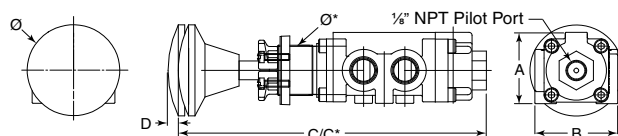

	A	B	C	C*	D	Ø	Ø*
	3-Way	4-Way	Travel				
Inches	2.3	1.62	7.88	8.38	.20	1.81	1.0
mm	58.4	41.2	200.1	212.9	5.08	46	25.4

For mounting hole dimensions see page 5

# THE C-316 SERIES

## Body Ported Valves

### PILOT, PALM BUTTON with DETENT

Side Ported	Function	Actuation	Pilot Type	Part Number	Weight	Flow Symbol
	3-Way 2-Position Normally Closed 3/2	Single Pilot Detent with Button	Remote Pilot	CAI-3301-316-150E	1.5 lbs 0.7 kg	
	3-Way 2-Position- Normally Open 3/2	Single Pilot Detent with Button	Remote Pilot	CIA-3302-316-150E	1.5 lbs 0.7 kg	
	4-Way 2-Position 5/2	Single Pilot Detent with Button	Remote Pilot	CAI-4302-316-150E	1.6 lbs 0.7 kg	

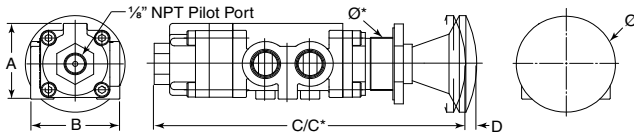

	A	B	C 3-Way	C* 4-Way	D Travel	Ø	Ø*
Inches	1.42	1.62	5.86	6.36	.20	1.81	1.0
mm	36.1	41.2	149	161.4	5.08	46	25.4

For mounting hole dimensions see page 5

### LATCHING, PILOT, SPRING RETURN without PALM BUTTON

Side Ported	Function	Actuation	Pilot Type	Part Number	Weight	Flow Symbol
	3-Way 2-Position Normally Closed 3/2	Pilot, Latching, Spring Return	Remote Pilot	CAP-3301-316-356BN	1.3 lbs 0.6 kg	
	3-Way 2-Position- Normally Open 3/2	Pilot, Latching Spring Return	Remote Pilot	CPA-3302-316-356BN	1.3 lbs 0.6 kg	
	4-Way 2-Position 5/2	Pilot, Latching Spring Return	Remote Pilot	CAP-4302-316-356BN	1.4 lbs 0.6 kg	

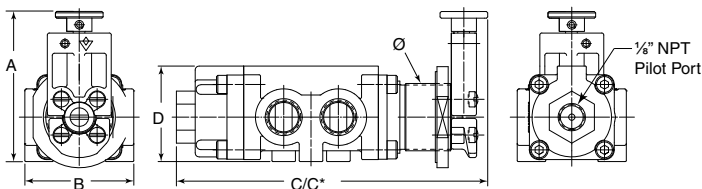

	A	B	C 3-Way	C* 4-Way	Ø
Inches	2.23	1.42	4.36	4.86	1.81
mm	56.6	36.1	117.5	123.4	46

For mounting hole dimensions see page 5

# THE C-316 SERIES

## Body Ported Valves

### LATCHING, PILOT, SPRING RETURN with PALM BUTTON

Side Ported	Function	Actuation	Pilot Type	Part Number	Weight	Flow Symbol
	3-Way 2-Position Normally Closed 3/2	Pilot, Latching Reset with Palm Button	Remote Pilot	CAP-3301-316-356B	1.4 lbs 0.6 kg	
	3-Way 2-Position- Normally Open 3/2	Pilot, Latching Reset with Palm Button	Remote Pilot	CPA-3302-316-356B	1.4 lbs 0.6 kg	
	4-Way 2-Position 5/2	Pilot, Latching Reset with Palm Button	Remote Pilot	CAP-4302-316-356B	1.5 lbs 0.7 kg	

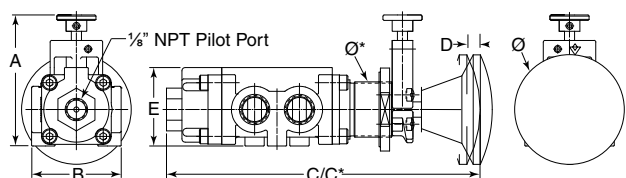

	A	B	C 3-Way	C* 4-Way	D Travel	E	Ø	Ø*
Inches	2.23	1.62	8.08	8.58	.20	2.3	1.81	1.0
mm	56.6	41.2	205.2	217.9	5.08	58.4	46	25.4

For mounting hole dimensions see page 5

### MANUAL, PALM BUTTON, SPRING RETURN

Side Ported	Function	Actuation	Pilot Type	Part Number	Weight	Flow Symbol
	3-Way 2-Position Normally Closed 3/2	Palm Button Spring Return	NA	CSI-3301-316	1.1 lbs 0.5 kg	
	3-Way 2-Position- Normally Open 3/2	Palm Button Spring Return	NA	CIS-3302-316	1.1 lbs 0.5 kg	
	4-Way 2-Position 5/2	Palm Button Spring Return	NA	CSI-4302-316	1.3 lbs 0.6 kg	

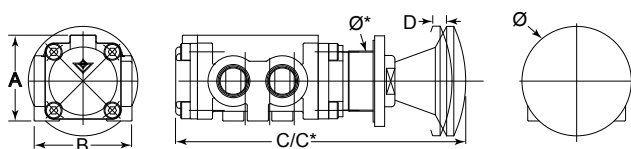

	A	B	C 3-Way	C* 4-Way	D Travel	Ø	Ø*
Inches	2.3	1.62	8.08	8.58	.20	1.81	1.0
mm	58.4	41.2	205.2	217.9	5.08	46	25.4

For mounting hole dimensions see page 5

# THE C-316 SERIES

## Body Ported Valves

### MANUAL, PALM BUTTON, DETENTED

Side Ported	Function	Actuation	Pilot Type	Part Number	Weight	Flow Symbol
	3-Way 2-Position Normally Closed 3/2	Palm Button Detent	NA	CZI-3301-316	1.3 lbs 0.6 kg	
	3-Way 2-Position- Normally Open 3/2	Palm Button Detent	NA	CIZ-3302-316	1.3 lbs 0.6 kg	
	4-Way 2-Position 5/2	Palm Button Detent	NA	CZI-4302-316	1.4 lbs 0.6 kg	

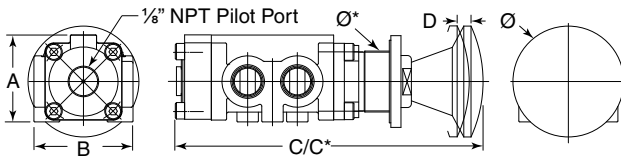

	A	B	C 3-Way	C* 4-Way	D Travel	Ø	Ø*
Inches	1.42	1.62	4.8	5.3	.20	1.81	1.0
mm	36.1	41.2	122	135	5.1	46	25.4

For mounting hole dimensions see page 5

### MANUAL, ROTARY, SPRING RETURN & DETENTED

Side Ported	Function	Actuation	Pilot Type	Part Number	Weight	Flow Symbol
	3-Way 2-Position Normally Closed 3/2	Spring Return  Detent	NA	CSA-3301-316-357E CZA-3301-316-357E(*)	1.6 lbs 0.7 kg 1.8 lbs 0.8 kg	
	3-Way 2-Position Normally Open 3/2	Spring Return  Detent	NA	CAS-3302-316-357E CAZ-3302-316-357E(*)	1.6 lbs 0.7 kg 1.8 lbs 0.8 kg	
	4-Way 2-Position 5/2	Spring Return  Detent	NA	CSA-4302-316-357E CAZ-3302-316-357E(*)	1.8 lbs 0.8 kg 2.0 lbs 0.9	

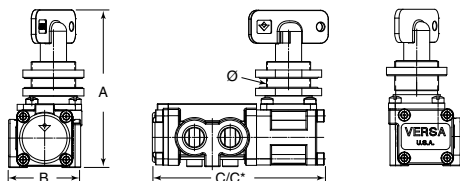

	A	B	C 3-Way	C* 4-Way	Ø
Inches	3.5	1.62	3.73	4.23	1.0
mm	90	41.2	95	107.4	25.4

For mounting hole dimensions see page 5

# THE C-316 SERIES

## Body Ported Valves

### MANUAL, KEY, SPRING RETURN & DETENT

Side Ported	Function	Actuation	Pilot Type	Part Number	Weight	Flow Symbol
	3-Way 2-Position Normally Closed 3/2	Spring Return	NA	CSA-3301-316-314E(*)	1.8 lbs 0.8 kg	
		Detent		CZA-3301-316-314E(*)	1.9 lbs 0.9 kg	
	3-Way 2-Position- Normally Open 3/2	Spring Return	NA	CAS-3302-316-314E(*)	1.8 lbs 0.8 kg	
		Detent		CAZ-3301-316-314E(*)	1.9 lbs 0.9 kg	
	4-Way 2-Position 5/2	Spring Return	NA	CSA-4302-316-314E(*)	2 lbs 0.9 kg	
		Detent		CAZ-4302-316-314E(*)		

\*Key Number - Key number assigned by Versa

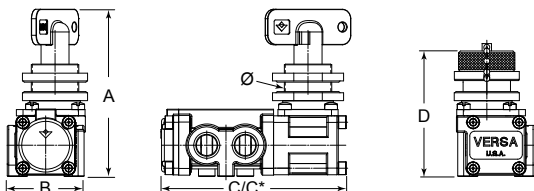

	A	B	C 3-Way	C* 4-Way	D	Ø
Inches	3.5	1.62	3.73	4.23	2.8	1.0
mm	90	41.2	95	107.4	71.3	24.5

For mounting hole dimensions see page 5

### MANUAL, KEY, PILOT RETURN

Side Ported	Function	Actuation	Pilot Type	Part Number	Weight	Flow Symbol
	3-Way 2-Position Normally Closed 3/2	Key Pilot Return	Remote Pilot	CPA-3301-316-314E(*)	2 lbs 0.9 kg	
		Key Pilot Return	Remote Pilot	CAP-3302-316-314E(*)	2 lbs 0.9 kg	
	4-Way 2-Position 5/2	Key Pilot Return	Remote Pilot	CPA-4302-316-314E(*)	2 lbs 0.9 kg	

\*Key Number - Key number assigned by Versa

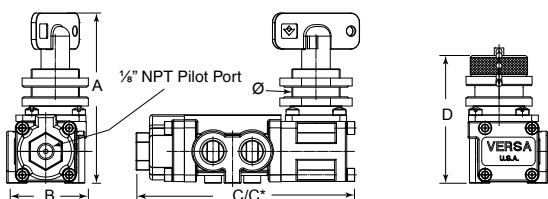

	A	B	C 3-Way	C* 4-Way	D	Ø
Inches	3.53	1.62	8.08	8.58	2.8	1.0
mm	90	41.2	205.2	217.9	71.3	24.5

For mounting hole dimensions see page 5

# THE C-316 SERIES

## Body Ported Valves

### MANUAL, LOCK - OUT

Side Ported	Function	Actuation	Pilot Type	Part Number	Weight	Flow Symbol
	3-Way 2-Position Normally Closed 3/2	Palm Button Detent	NA	CIZ-3301-316-LOVBE	1.3 lbs 0.6	
	4-Way 2-Position 5/2	Palm Button Detent	NA	CIZ-4302-316-LOVEE	1.4 lbs 0.6	

Note: locks not included

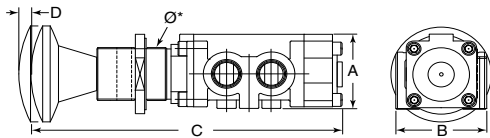

	A	B	C (3-Way)	C* (4-Way)	D (Travel)	Ø	Ø*
Inches	2.3	1.62	8.08	8.58	.20	1.81	1.0
mm	58.4	41.2	205.2	217.9	5.08	46	25.4

For mounting hole dimensions see page 5

### MANUAL, By Pass Valve

Side Ported	Function	Actuation	Pilot Type	Part Number	Weight	Flow Symbol
	1/4" NPT* 4Way 3-Position	Key Operated	NA	CAU-430X-316-314E***-2039  (***) = key code assigned at factory Add -9E Suffix Detail for Extended Plunger	2 lbs 0.9 kg	

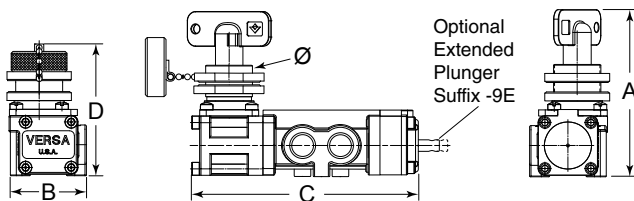

	A	B	C	D*	E	Ø
Inches	3.53	1.62	5.14	4.7	2.8	1.0
mm	90	41.2	130	217.9	71.3	24.5

For mounting hole dimensions see page 5

The, basic valve is a 3 position manual valve. Operation is as follows:

Position 1. This position is the normal position or the regular operation mode.

Position 2. This position places the control circuit in the test mode. In this position the bypass valve allows pressure to the circuit for testing while maintaining pressure on the actuator. With pressure to solenoid inlet and solenoid circuit outlet blocked/isolated this position allows complete testing of solenoid circuit while not shutting down the system.

Position 3. This position places the control system in a replace mode. Should it be determined that a component in the control circuit needs to be repaired and or replaced this position allows total isolation from pressure while still holding system pressure to actuator.

\*1/2" NPT available; part number: VAU-450X-316-314E507-2039. See V-316 Series.



# THE C-316 SERIES

## Body Ported Valves

### MANUAL, CAM

Side Ported	Function	Actuation	Pilot Type	Part Number	Weight	Flow Symbol
	3-Way 2-Position Normally Closed 3/2	Cam Spring Return	NA	CSC-3301-316	1.0 lbs 0.5 kg	
	3-Way 2-Position Normally Open 3/2	Cam Spring Return	NA	CCS-3302-316	1.0 lbs 0.5 kg	
	4-Way 2-Position 5/2	Cam Spring Return	NA	CSC-4302-316	1.0 lbs 0.5 kg	

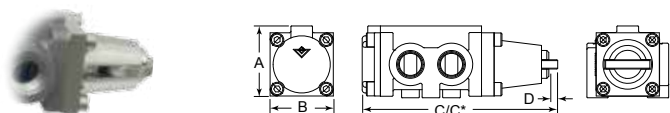

Standard Cam

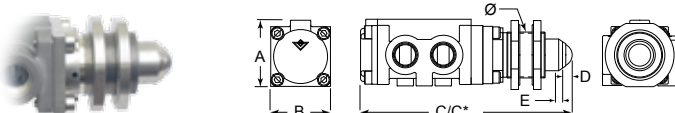

Over Travel Cam Suffix -18E

	A	B	C (3-Way)	C* (4-Way)	D (Travel)	E (Over Travel)	Ø
Inches	1.42	1.62	3.87	4.37	.20	0.19	1.0
mm	58.4	41.2	110.9	217.9	5.08	4.8	25.4

For mounting hole dimensions see page 5

## Options

### Override



-ME  
Override

On Standard Solenoid Cap



-ME -U  
Override

On Up Right Solenoid Cap

### Solenoid Vent Options



Hydraulic Adapter

-H2 1/8"  
-H 1/4"



Excluders

-L14  
Dust Proof



-D14  
Water Tight

### Stainless Steel Tag

#### ORDERING INFORMATION

Order any B-316, C-316, T, V or V-316 valve. As a separate line item (listed directly under valve part number to be tagged) list the tag part number P- 2002-16-NV28A. In remarks field specify the tag marking instructions. If sequential numbering is required provide the start and end numbers required in the sequence for the appropriate number of valves.



#### Engraving Options

Versa's engraved tags are available in two configurations.

Configuration one: is a simple text field consisting of two lines of text, 20 characters maximum per line. The text can be specified as alpha, numeric or both.

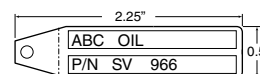

Configuration two: is a text field with sequential numbering added. This option includes two lines of text. Line one is text. Line two allows for sequentially numbering the tag, 20 characters maximum per line.

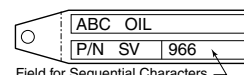

Field for Sequential Characters

# THE C-316 SERIES NAMUR

Note:  
3-Way & 4-Way  
NAMUR valves  
look the same  
externally.

## NAMUR, SOLENOID OPERATED

NAMUR	Function	Actuation	Pilot Type	Part Number	Weight	Flow Symbol
	3-Way 2-Position Normally Closed 3/2	Single Solenoid Spring Return	Inpilot	CGS-3331-316-NE†-(* )	1.7 lbs 0.8 kg	
	3-Way 2-Position- Normally Open 3/2	Single Solenoid Spring Return	Inpilot	CSG-3332-316-NE†-(* )	1.7 lbs 0.8 kg	
	3-Way 2-Position 3/2	Double Solenoid Detent	Inpilot	CGG-3331-316-NE†-(* )	2.3 lbs 1.0 kg	
	4-Way 2-Position 5/2	Single Solenoid Spring Return	Inpilot	CGS-4332-316-NE†-(* )	1.7 lbs 0.8 kg	
	4-Way 2-Position 5/2	Double Solenoid Detent	Inpilot	CGG-4332-316-NE†-(* )	2.3 lbs 1.0 kg	

† Add mounting screw type from Selector Chart "Suffix" column (page 3) \* Add solenoid/coil voltages (page 19) & Suffix from Selector Chart (page 3).

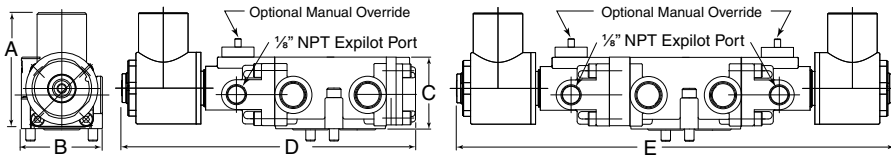

	A	B	C	D
Inches	2.3	1.62	5.7	8.8
mm	58.4	41.2	144	223

Solenoid shown is hazardous location type -XX. For more options see page 18. Manual override see page 15

## NAMUR LATCHING, SOLENOID, SPRING RETURN without PALM BUTTON

NAMUR	Function	Actuation**	Pilot Type	Part Number	Weight	Flow Symbol
	3-Way 2-Position Normally Closed 3/2	Pilot, Latching Reset without Button	Inpilot	CAG-3331-316-356BN-NE†-(* )	1.5 lbs 0.7 kg	
	3-Way 2-Position- Normally Open 3/2	Pilot, Latching Reset without Button	Inpilot	CGA-3332-316-356BN-NE†-(* )	1.5 lbs 0.7 kg	
	4-Way 2-Position 5/2	Single Solenoid, Latching Reset without Button	Inpilot	CAG-4332-316-356BN-NE†-(* )	1.5 lbs 0.7 kg	

† Add mounting screw type from Selector Chart "Suffix" column (page 3). \* Add solenoid/coil voltages (page 19) & Suffix from Selector Chart (page 5).

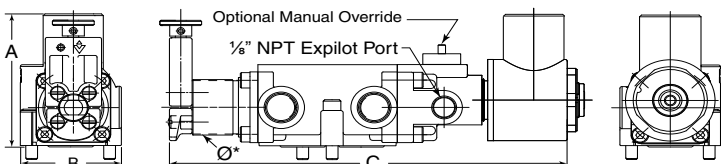

\*\*Consult  
factory for other  
configurations

	A	B	C	Ø*
Inches	2.23	1.62	5.7	1
mm	56.6	41.2	144	25.4

Solenoid shown is hazardous location type -XX. For more options see page 18. Manual override see page 15

# THE C-316 SERIES

## CMAP Modular Air Package

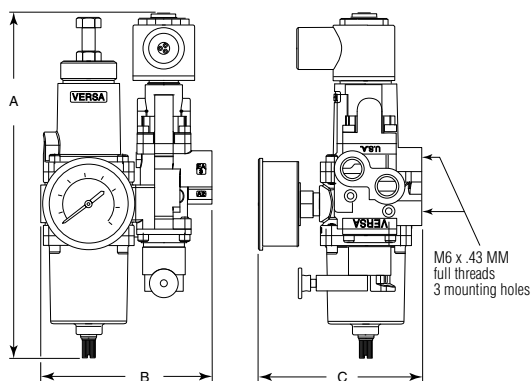

	A	B	C
Inches	8.44	4.0	3.85
mm	214	101.6	97.9

### Bill of Materials

Description	Part Number
Regulator	ARFA-3111-316-CA3-GBG
Valve	CAG-3321-316-356BN-CA3-XX-A120

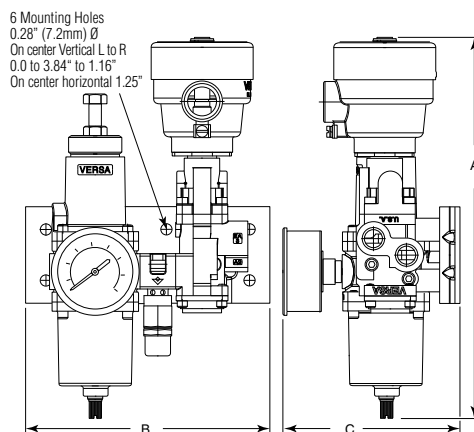
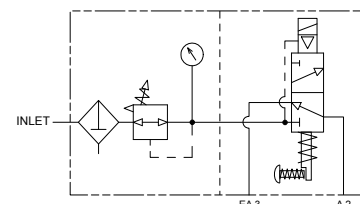

	A	B	C
Inches	9.39	6.0	3.85
mm	238	152.4	97.9

### Bill of Materials

Description	Part Number
Regulator	ARFA-3111-316-CA3-GBG
Valve	CSG-3321-316-CA3-XDBS1-A120
Spacer	CY-3209-32-316-CA3
Bracket	4302-99-316-CA3
Relief Valve	RV-3-316-100

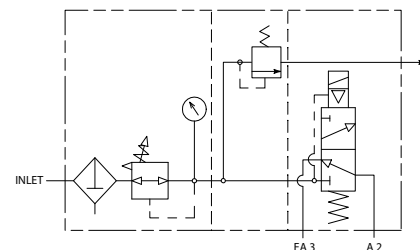

### Air Prep Selection

Regulator, Filter and manual drain*	Description	Part Number		Weights	
		0-100 psi	0-150 psi	lbs	kg
	No gauge	ARFA-3112-316-CA3	ARFA-3111-316-CA3	2.7	1.22
	2" gauge liquid filled	ARFA-3112-316-CA3-GBG	ARFA-3111-316-CA3-GBG	2.9	1.32
	2 1/2" gauge liquid filled	ARFA-3112-316-CA3-GAG	ARFA-3111-316-CA3-GAG	2.9	1.32

### Valve Selection

Description	Part Number		Weights ††	
	3-way, normally closed †	3-way, normally open †	lbs	Kg
3/2 Pilot, Spring Return	CSG-3321-316-CA3-**	CGS-3322-316-CA3-**	1.9	0.86
3/2 Double Pilot, detented	CGG-3321-316-CA3-**	CGG-3322-316-CA3-**	2.5	1.13
3/2 Pilot, spring return w/ latch	CAG-3321-316-CA3-356BN-**	CGA-3322-316-CA3-356BN-**	2.2	0.99
3/2 Pilot, spring return w/ latch and button	CAG-3321-316-CA3-356B-**	CGA-3322-316-CA3-356B-**	2.3	1.04
3/2 Pilot, spring return	CSP-3301-316-CA3	CPS-3302-316-CA3	1.3	0.59

### Accessories

Description	Part Number	Weights	
		lbs	kg
Mounting bracket	Add 4302-99-316-CA3 to bill of Material	0.5	0.23
Auxiliary port plate	Add CY-3209-32-316-CA3 to bill of Material	0.2	0.09
Relief Valve (also specify Aux port plate)	Add RV-3-316-*** to bill of Material	0.2	0.09
Speed Control, close only	Add suffix -BC3 to Control Valve p/n	0.1	0.05
Speed Control, both open closed	Add FCV-3-316 to bill of Material	0.5	0.23

### Notes:

- \* For regulator auto drain, consult factory
- \*\* Add voltage and Pilot options. See page 19
- † For expilot change 3321 to 3301
- †† Weight are for -XX type Pilots
- \*\*\* Add set pressure, for example RV-3-316-080 for 80 psi



**Versa  
has been  
supplying the  
oil and gas  
industry with  
pneumatic  
and hydraulic  
components  
for over 50  
years. We  
have built a  
reputation  
for quality  
that is  
unsurpassed  
in the market  
for high  
performance  
solenoids,  
pneumatic  
relays, resets  
and pilot  
valves**

#### WARNINGS REGARDING THE DESIGN APPLICATION, INSTALLATION AND SERVICE OF VERSA PRODUCTS

The warnings below must be read and reviewed before designing a system utilizing, installing, servicing, or removing a Versa product. Improper use, installation or servicing of a Versa product could create a hazard to personnel and property.

#### DESIGN APPLICATION WARNINGS

Versa products are intended for use where compressed air or industrial hydraulic fluids are present. For use with media other than specified or for non-industrial applications or other applications not within published specifications, consult Versa.

Versa products are not inherently dangerous. They are only a component of a larger system. The system in which a Versa product is used must include adequate safeguards to prevent injury or damage in the event of system or product failure, whether this failure be of switches, regulators, cylinders, valves or any other system component. System designers must provide adequate warnings for each system in which a Versa product is utilized. These warnings, including those set forth herein, should be provided by the designer to those who will come in contact with the system.

Where questions exist regarding the applicability of a Versa product to a given use, inquiries should be addressed directly to the manufacturer. Confirmation should be obtained directly from the manufacturer regarding any questioned application prior to proceeding.

#### INSTALLATION, OPERATION AND SERVICE WARNINGS

Do not install or service any Versa product on a system or machine without first depressurizing the system and turning off any air, fluid, or electricity to the system or machine. All applicable electrical, mechanical, and safety codes, as well as applicable governmental regulations and laws must be complied with when installing or servicing a Versa product.

Versa products should only be installed or serviced by qualified, knowledgeable personnel who understand how these specific products are to be installed and operated. The individual must be familiar with the particular specifications, including specifications for temperature, pressure, lubrication, environment and filtration for the Versa product which is being installed or serviced. Specifications may be obtained upon request directly from Versa. If damages should occur to a Versa product, do not Operate the system containing the Versa product. Consult Versa for technical information.

#### LIMITED WARRANTY DISCLAIMER AND LIMITATION OF REMEDIES

Versa's Series products are warranted to be free from defective material and workmanship for a period of ten years from the date of manufacture, provided said products are used in accordance with Versa specifications. Versa's liability pursuant to that warranty is limited to the replacement of the Versa product proved to be defective provided the allegedly defective product is returned to Versa or its authorized distributor. Versa provides no other warranties, expressed or implied, except as stated above. There are no implied warranties of merchantability or fitness for a particular purpose. Versa's liability for breach of warranty as herein stated is the only and exclusive remedy and in no event shall Versa be responsible or liable for incidental or consequential damages.

Versa Products Company Inc.  
22 Spring Valley Road  
Paramus, New Jersey 07652  
USA  
Phone: 201-843-2400  
Fax: 201-843-2931

Versa BV  
Prins Willem Alexanderlaan  
1429  
7321 GB Apeldoorn  
The Netherlands  
Phone: 01131-55-368-1900  
Fax: 01131-55-368-1909



www.versa-valves.com  
email: sales@versa-valves.com