



# Transportation

Air Brake Tubing

Diesel Fuel Tubing

High Temperature Fuel Tubing

Truck Coils

Cut Tubes

Formed Tubes

Jacketed Bundles

Air Brake Harnesses

SCR Hose

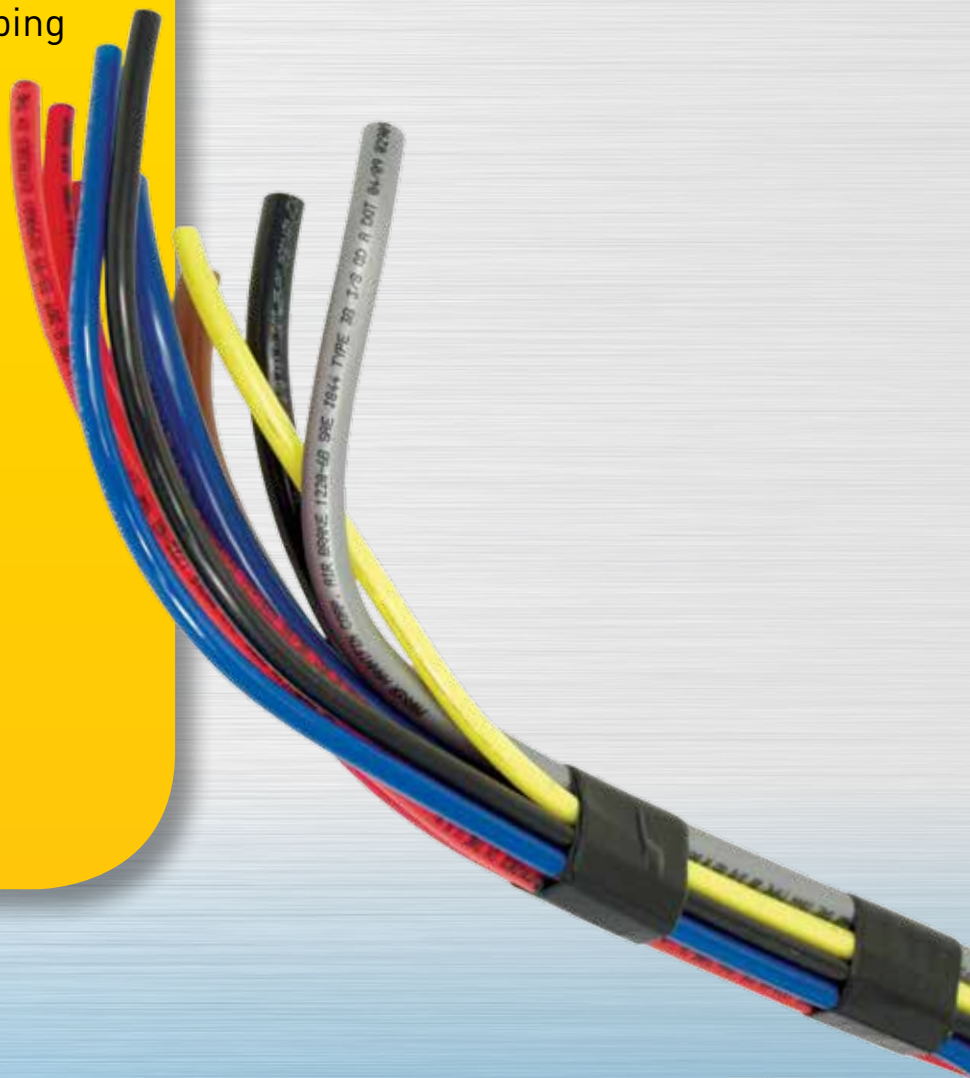













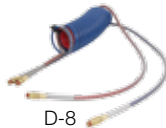

# Table of Contents

Air Brake Tubing .....D-4  
 PFT-FL Diesel Fuel Tubing .....D-5  
 HTFL Diesel Fuel Tubing, High Temp .....D-6  
 BRAKCoil® .....D-7  
 Duo-Coil™ .....D-8  
 DollyCoil™ .....D-9

SliderCoil™ .....D-10  
 Fifth Wheel Slider .....D-11  
 Cut Tubes .....D-12  
 Formed Tubes and Hoses .....D-12  
 Jacketed Bundles .....D-12  
 Straight Harnesses .....D-12

Formed Harnesses .....D-12  
 SCR Hose .....D-13

## Transportation Visual Index

Transportation Products	Air Brake Tubing	PFT-FL Diesel Fuel Tubing	HTFL High-Temperature Diesel Fuel Tubing	BRAKCoil®	Duo-Coil®
	 D-4	 D-5	 D-6	 D-7	 D-8
	DollyCoil™	SliderCoil™	Fifth Wheel Slider	Cut Tubes	Formed Tubes & Hoses
	 D-9	 D-10	 D-11	 D-12	 D-12
	Jacketed Bundles	Straight Harnesses	Formed Harnesses	SCR Hose	
	 D-12	 D-12	 D-12	 D-13	



# Parflex Transportation Products

Formed Dash Harnesses  
Transmission Air Shift Bundles  
Cab Tilt Lines

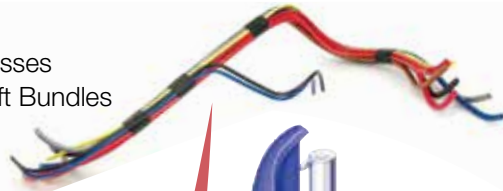

Air Brake Tubing  
Air Brake Harnesses



Slider Coils  
Tire Inflation Hoses

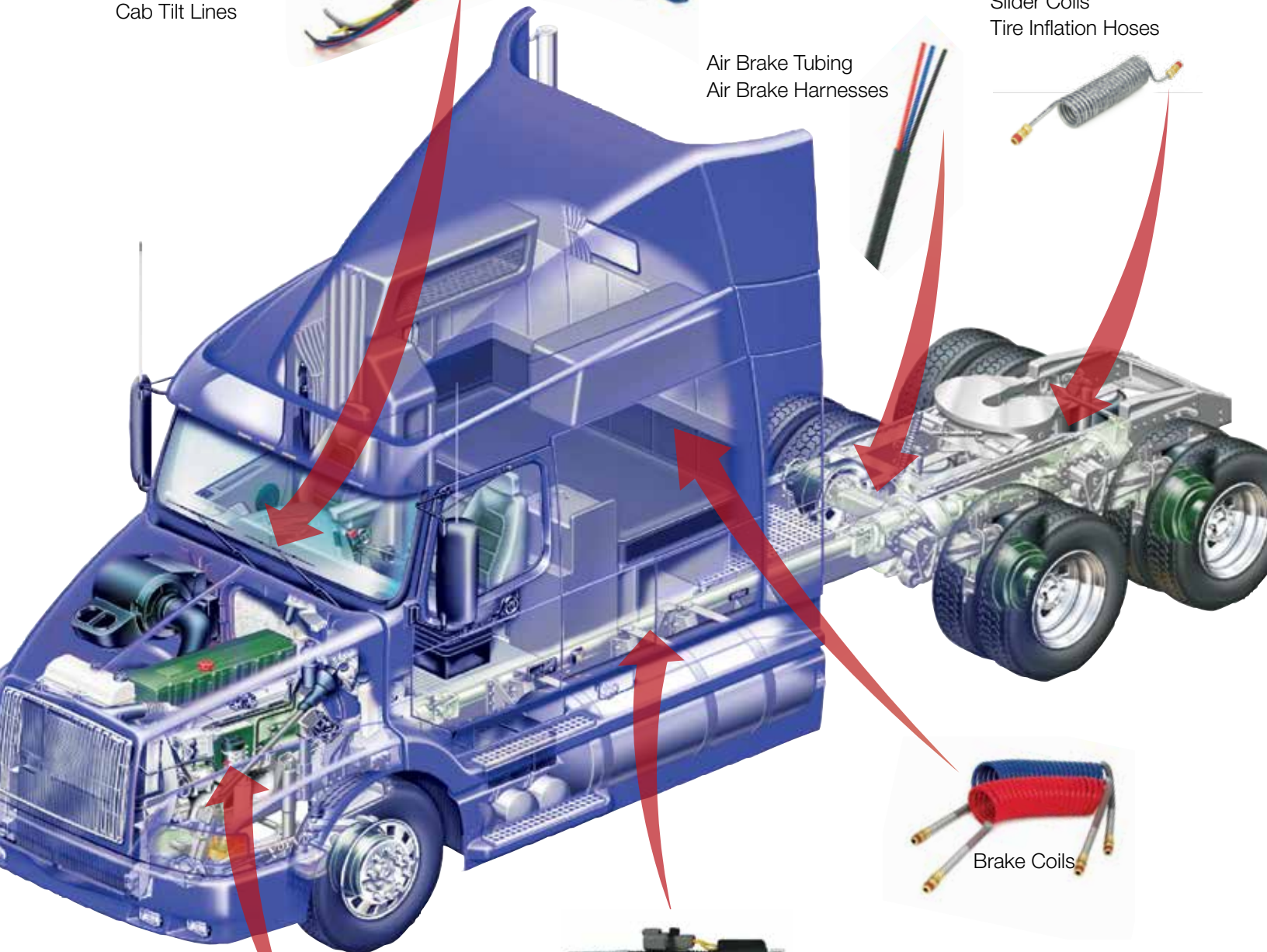

Brake Coils



Heated SCR Hose  
Fuel Tubing  
High Temp Fuel Lines



Compressor Discharge Lines  
Formed Power Steering Hoses

*For detailed ordering information, please consult price list or contact Parflex® Division.*

Parker Hannifin Corporation | Parflex® Division | Ravenna, Ohio | [parker.com/pfd](http://parker.com/pfd)



# 1120 Nylon Air Brake Tubing

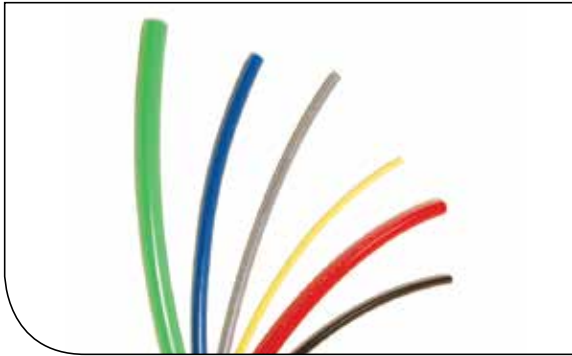

## Features

- 100% Pressure Tested
- Excellent UV Stability
- Abrasion Resistant
- Kink Resistant

## Certifications

- Meets SAE Specification J844
- Meets DOT FMVSS 49CFR 571.106

## Applications/Markets



- Air brake lines

Part Number	Tube O.D.		Outside Diameter		Inside Diameter		Nominal Wall Thickness		Burst Pressure at 73°F / 23°C		Minimum Bend Radius		Weight		Standard Reel		Standard Pallet	
	inch	mm	inch	mm	inch	mm	inch	mm	psi	bar	inch	mm	lbs./100 ft.	kg./31 mtr.	feet	meter	feet	meter
#																		
1120-2A-XXX-1000	1/8	.125	3.2	.079	2.0	.023	0.6	1000	69.0	.370	9.4	.340	.154	1000	305	24,000	7315	
1120-2.5A-XXX-1000	5/32	.156	4.0	.092	2.3	.032	0.8	1200	82.7	.500	12.7	.570	.259	1000	305	24,000	7315	
1120-3A-XXX-1000	3/16	.188	4.8	.118	3.0	.035	0.9	1200	82.7	.750	19.1	.770	.349	1000	305	24,000	7315	
1120-4A-XXX-1000	1/4	.250	6.4	.170	4.3	.040	1.0	1200	82.7	1.00	25.4	1.21	.549	1000	305	24,000	7315	
1120-5A-XXX-500	5/16	.313	7.9	.232	5.9	.040	1.0	1000	69.0	1.25	31.8	1.57	.712	500	152	12,000	3658	
1120-6B-XXX-500	3/8	.375	9.5	.251	6.4	.062	1.6	1400	96.5	1.50	38.1	2.70	1.22	500	152	12,000	3658	
1120-8B-XXX-500	1/2	.500	12.7	.376	9.6	.062	1.6	950	65.5	2.00	50.8	3.90	1.77	500	152	6,000	3658	
1120-10B-XXX-250	5/8	.625	15.9	.441	11.2	.092	2.3	900	62.1	2.50	63.5	7.00	3.18	250	76	3,000	914	
1120-12B-XXX-250	3/4	.750	19.1	.566	14.4	.092	2.3	800	55.2	3.00	76.2	8.60	3.90	250	76	3,000	914	

XXX represents color code.

## Construction

Material:  
Type A – Single-wall extruded Nylon (polyamide)

Type B – Nylon (polyamide) core, fiber reinforcement, Nylon (polyamide) cover/sheath

## Operating Parameters

Temperature Range:  
-40°F to +200°F (-40°C to +93°C)

Working Pressure: 150 psi (10.3 bar)

## Fittings

Parker Fittings available from:  
Fluid System Connectors Division  
Otsego, MI  
(269) 692-6555  
(269) 694-4614 FAX

FSC Product Families:

- NTA
- PMT
- PTC

## Colors

Color Code		
●	BLK	Black
●	BLU	Blue
●	BRN	Brown
●	GRN	Green
●	ORG	Orange
●	PUR	Purple
●	RED	Red
●	SIL	Silver
●	TAN	Tan
●	YEL	Yellow
○	WHT	White

# Parflex Diesel Fuel Tubing



## Features

- Nylon tubing designed for use in tractor, trailer and other mobile fuel systems
- Heat and light stabilized
- 100% quality controlled - 100% pressure tested
- Saves weight and labor in comparison with hose and hard-line tubing

## Approvals

- Compatible with JP-5 (MIL-DTL-5624) and JP-8 (MIL-DTL-83133)
- Compatible with Biodiesel per Parflex PPB PL-18 hard-line tubing

## Applications/Markets



- D.O.T. diesel fuel applications

Part Number	Nominal Tube O.D.		Nominal Tube I.D.		Minimum Bend Radius		Weight		Standard Reel	
	inch	mm	inch	mm	inch	mm	lbs./ft.	kg./mtr.	feet	meter
#										
PFT-4A-XXX-1000-FL	1/4	6	.170	4	1	25	.012	.005	1000	305
PFT-6B-XXX-500-FL	3/8	10	.251	6	1-1/2	38	.027	.012	500	152
PFT-8B-XXX-500-FL	1/2	13	.376	10	2	51	.039	.018	500	152
PFT-10B-XXX-250-FL	5/8	16	.441	11	2-1/2	64	.070	.032	250	76
PFT-12B-XXX-250-FL	3/4	19	.566	14	3	76	.086	.039	250	76

XXX represents color code.

## Construction

Heat and light stabilized seamless extruded nylon core reinforced with fibrous reinforcement and bonded with a protective blue nylon cover sheath

## Operating Parameters

Temperature Range:

-40°F to +200°F (-40°C to +93°C)

Maximum Working Pressure: 150 psi (10.3 bar)

Do not exceed temperature and pressure ranges

## Color

- BLU

Blue is standard

Consult division for additional colors

## Fittings

Parker Fittings available from:  
Fluid System Connectors Division  
Otsego, MI  
(269) 692-6555  
(269) 694-4614 FAX

FSC Product Families:

- NTA
- DF (Diesel Fuel Only)

## Notes

Contact Parflex Division for application review

For detailed ordering information, please consult price list or contact Parflex® Division.

Parker Hannifin Corporation | Parflex® Division | Ravenna, Ohio | [parker.com/pfd](http://parker.com/pfd)



D-5

A Hose  
 B Tubing  
 C Coiled Air Hose & Fittings  
 D Transportation  
 E Fittings  
 F Tooling, Equipment & Accessories  
 G General Technical

# HTFL Diesel Fuel Line Tubing (High-Temperature)



## Features

- Heat and UV stabilized
- For use in high temperature applications
- 100% Pressure Tested
- Lightweight
- Pre-formed tubes available

## Applications/Markets



Part Number	Nominal Tube O.D.		Nominal Tube I.D.		Nominal Wall Thickness		Working Pressure		Minimum Burst at 73°F / 23°C		Minimum Bend Radius		Weight		Standard Reel	
	inch	mm	inch	mm	inch	mm	psi	bar	psi	bar	inch	mm	lbs./ft.	kg./mtr.	feet	meter
#																
HTFL-6B-BRN-500	3/8	10	.251	6	.062	1.6	175	12.1	1,400	96.5	1-1/2	38	.028	.013	500	152
HTFL-8B-BRN-500	1/2	13	.376	10	.062	1.6	155	10.7	950	65.5	2	51	.039	.018	500	152
HTFL-10B-BRN-250	5/8	16	.441	11	.092	1.6	140	9.7	900	62.1	2-7/8	73	.071	.032	250	76
HTFL-12B-BRN-250	3/4	19	.566	14	.092	1.6	150	10.3	800	55.1	3	76	.086	.039	250	76

## Construction

Tube: High-temperature and chemical-resistant special polyamide

Reinforcement: High-strength yarn fiber

Cover: High-temperature and UV-resistant special polyamide

## Operating Parameters

Temperature Range:

-50°F to +266°F (-46°C to +130°C)

Vacuum Rating: 28 inch Hg

## Fittings

Parker Fittings available from:  
Fluid System Connectors Division  
Otsego, MI  
(269) 692-6555  
(269) 694-4614 FAX

FSC Product Families:

NTA

## Color

● BRN

Brown is standard

Consult division for additional colors

## Notes

Compatible with JP-5 (MIL-DTL-5624) and JP-8 (MIL-DTL-83133)

Compatible with Biodiesel per Parflex PPB PL-18

# BRAKCOIL®

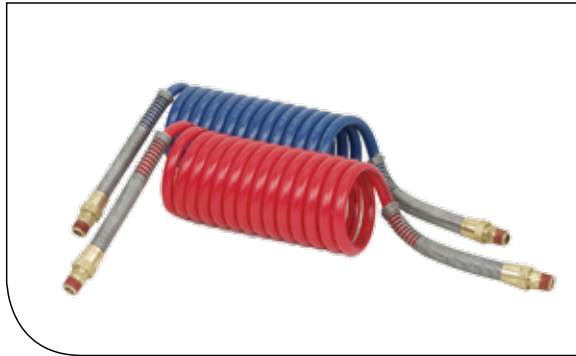

## Features

- Tractor-to-trailer coiled nylon air-brake connections
- Maintenance-free performance - designed for trouble-free service on your rig
- Years of city delivery and line haul testing
- Heavy-duty plated spring guards are rust-resistant for added protection
- More coils offer you maximum working lengths
- No need for pogo sticks or spring hangers
- Color coding gives you mistake-free hook-ups - blue for service, red for emergency

## Certifications

- Meets or exceeds SAE J844 and D.O.T. FMVSS 106 Specifications at -70°F to +200°F

## Applications/Markets



- Tractor to Trailer

Kit Coil Number	Individual Coil Part Number	Tube O.D.		Valve Tail Length		Brass Male Ends (NPT)				Working Length		Number of Coils
						Valve		Gladhand				
#	#	⊙										
		inch	mm	inch	mm	inch	mm	inch	mm	feet	meter	
731516	731512-Red 731512-Blue	-8	13	12	305	1/2	13	1/2	13	15	4.6	21-1/2
751597	731611-Red 731611-Blue	-8	13	12	305	3/8	10	1/2	13	15	4.6	21-1/2
731522	731513-Red 731513-Blue	-8	13	40	1016	1/2	13	1/2	13	15	4.6	21-1/2
741526	731612-Red 731612-Blue	-8	13	40	1016	3/8	10	1/2	13	15	4.6	21-1/2
751641	741590-Red 741590-Blue	-8	13	6	152	1/2	13	1/2	13	12	3.7	18-1/2
751655	751656-Blk Black Only	-8	13	6	152	3/8	10	1/2	13	12	3.7	18-1/2

## Order Information

BRAKCOIL® kits are supplied complete – **Parker pre-assembled**, with everything needed, including spring guards and male pipe NTA brass fittings, **ready to install**. Special pipe thread sealant is factory applied. No cutting or assembly necessary. Just attach the gladhands (sold separately or pre-assembled). They are available in kits or as separate lines. A kit consists of both a red and blue tube assembly.

## Construction

Tube: Coiled Nylon Air Brake Tubing

## Operating Parameters

Temperature Range:  
-70°F to +200°F (-57°C to +93°C)

## Options

Extended BRAKCOIL handle available, part no. 771164

Gladhands available

- Blue - Part # GH9211
- Red - Part # GH9212

For detailed ordering information, please consult price list or contact Parflex® Division.

Parker Hannifin Corporation | Parflex® Division | Ravenna, Ohio | [parker.com/pfd](http://parker.com/pfd)



# Duo-Coil™ Features



## Features

- Duo-Coil combines both tractor-to-trailer lines (service and emergency) into a strong single unit
- Designed for quick hook-up and trouble-free service on your rig
- Reverse winding of the coiled air brake lines eliminates the possibility of tangling
- Installation swivel fittings make hook-up a snap
- The inner red emergency coil is wound inside the blue service coil offering added protection to the driver
- The single unit provides clean and neat installation

## Certifications

- Meets or exceeds SAE J844 and D.O.T. FMVSS 106 Specifications at -70°F to +200°F

## Applications/Markets



- Tractor to Trailer

Kit Coil Number	Tube O.D.		Valve Tail Length		Brass Male Ends (NPT)				Working Length		Number of Coils
					Valve		Gladhand				
#	⊙										
	inch	mm	inch	mm	inch	mm	inch	mm	feet	meter	
801048	-8	13	12	305	1/2	13	1/2	13	15	4.6	21-1/2
801632	-8	13	6	152	1/2	13	1/2	13	12	3.7	18-1/2
801595	-8	13	40	1016	1/2	13	1/2	13	15	4.6	21-1/2

## Order Information

Duo-Coil™ kits are supplied complete – **Parker pre-assembled**, with everything needed, including spring guards and pipe end NTA fittings, **ready to install**. Special pipe thread sealant is factory applied. No cutting or fitting assembly is necessary. Just attach the gladhands (sold separately or pre-assembled).

## Construction

Tube: Coiled Nylon Air Brake Tubing

## Operating Parameters

Temperature Range:  
-70°F to +200°F (-57°C to +93°C)

## Options

Extended BRAKCOIL handle available, part no. 771164

Gladhands available

- Blue – Part # GH9211
- Red – Part # GH9212



# DollyCoil™



## Features

- No need to install springs or hangers
- Will retract to its original shape even after long periods of extended use

## Certifications

- Meets or exceeds SAE J844 and D.O.T. FMVSS 106 Specifications at -70°F to +200°F

## Applications/Markets



- Multiple Trailers
- Converter Dollies

Kit Coil Number	Tube O.D.		Valve Tail Length		Brass Male Ends (NPT)				Standard Working Length		Number of Coils
					Valve 90° End		Gladhand 180° End				
#	⊙										
	inch	mm	inch	mm	inch	mm	inch	mm	feet	meter	
751634	-8	13	8	13	1/2	13	1/2	13	6	1.83	12

## Order Information

DollyCoil™ kits are supplied complete – **Parker pre-assembled**, with everything needed, including spring guards and male pipe end NTA fittings, **ready to install**. Special pipe thread sealant is factory applied. No cutting or assembly necessary. Just attach the gladhands (sold separately or pre-assembled). They are available in kits or as separate lines. A kit consists of both a red and blue tube assembly.

## Construction

Tube: Coiled Nylon Air Brake Tubing

## Operating Parameters

Temperature Range:  
-70°F to +200°F (-57°C to +93°C)

## Options

Extended BRAKCOIL handle available, part no. 771164

Gladhands available

- Blue – Part # GH9211
- Red – Part # GH9212

For detailed ordering information, please consult price list or contact Parflex® Division.

Parker Hannifin Corporation | Parflex® Division | Ravenna, Ohio | [parker.com/pfd](http://parker.com/pfd)



A Hose  
 B Tubing  
 C Coiled Air Hose & Fittings  
 D Transportation  
 E Fittings  
 F Tooling, Equipment & Accessories  
 G General Technical

# SliderCoil™

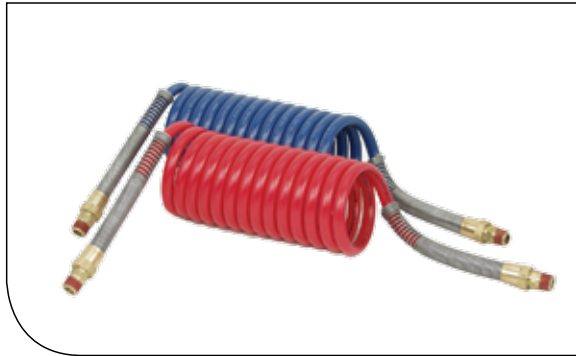

## Features

- Used between an adjustable rear trailer axle and the final point on a trailer chassis
- No need to install springs or hangers
- Will retract to its original shape even after long periods of extended use

## Certifications

- Meets or exceeds SAE J844 and D.O.T. FMVSS 106 Specifications at -70°F to +200°F

## Applications/Markets



- Tractor Trailers (Sliding)
- Tractor Trailers (Axles)

Kit Coil Number	Individual Coil Part Number	Tube O.D.		Valve Tail Length		Brass Male Ends (NPT)				Working Length		Number of Coils
						Valve 90° End		Gladhand 180° End				
#	#											
		inch	mm	inch	mm	inch	mm	inch	mm	feet	meter	feet
751657	751658-BLU, RED	-8	13	8	13	1/4	6	1/4	6	13-1/2	4.1	9
751659	751660-BLU, RED	-8	13	8	13	3/8	10	3/8	10	13-1/2	4.1	9

## Order Information

SliderCoil™ kits are supplied complete – **Parker pre-assembled**, with everything needed, including spring guards and male pipe end NTA fittings, **ready to install**. Special pipe thread sealant is factory applied. No cutting or assembly necessary. They are available in kits or as separate lines. A kit consists of both a red and blue coil assemblies.

## Construction

Tube: Coiled Nylon Air Brake Tubing

## Operating Parameters

Temperature Range: -70°F to +200°F (-57°C to +93°C)

## Color

- Blue
- Red

## Options

Extended BRAKCOIL handle available, part no. 771164

# Fifth Wheel Slider Coil



## Features

- Clutter-free hook-up and maintenance-free performance of adjustable length pneumatic tubing for fifth wheel sliding action
- Self-adjusts from 10" to fully extended 74" working length
- Universal, ready for immediate installation
- No maintenance required - stays on the job at peak performance through years of trouble-free life
- Coil set is strong and permanent - Even after prolonged use in fully extended position, coils will retract to shorter length without sagging and eliminating hazards of chafing and wear

## Certifications

- Conforms to SAE Specification J844 Type A
- Meets D.O.T. FMVSS 106

## Applications/Markets



- Double Trailers
- Covert, Dollies

Part Number	Fittings	Pigtail Length		Max. Extended Length		Retracted Length	
		inch	mm	inch	mm	inch	mm
#							
811537	(2)68NTA-4-4	2	51	74	1880	10	254
811537-NF-BLK	-	2	51	74	1880	10	254

## Order Information

Fifth Wheel Slider Coil part# 811537 comes complete with fittings. Part# 811537-NF-BLK does not include fittings.

## Construction

Tube: 1/4" O.D. extruded Nylon, heat and light stabilized, single wall

## Operating Parameters

Temperature Range: -40°F to +200°F (-40°C to +93°C)

## Color

- SIL

## Options

Available with or without fittings

For detailed ordering information, please consult price list or contact Parflex® Division.

Parker Hannifin Corporation | Parflex® Division | Ravenna, Ohio | [parker.com/pfd](http://parker.com/pfd)



D-11

A Hose  
 B Tubing  
 C Coiled Air Hose & Fittings  
 D Transportation  
 E Fittings  
 F Tooling, Equipment & Accessories  
 G General Technical

# Custom Harness, Bundles & Tubing

## Order Information

Several different harnesses may be required on a single unit depending upon the model of the vehicle, wheel base and options available. To determine your harness application needs:

- 1. Recognize the cost savings** available to you through the use of harnesses. How many dollars will be saved on tubing installation alone? On scrap reduction?
- 2. Call Parker.** Have one of our application engineers study your application.
- 3. Have Parker engineers design and build a prototype** harness for your approval.
- 4. Approve the prototype** as our basis to engineer your production model harness.
- 5. Implement the harness** into your Purchasing and Production systems – one harness, one part number instead of multiple part numbers you once had for each air brake line.

## Features

- Preformed, pre-bundled tubing or hose custom designed to reduce installation time and improve throughput
- Your production line will run faster and be virtually free from tubing scrap
- Individual tubes are pre-cut and assembled into a single unit

## Certifications

- Designed and engineered to meet the exacting requirements of each bus or truck manufacturer for each vehicle
- The air brake tubing used in a Parflex Harness conforms to SAE J844 type 3A and 3B and also D.O.T. FMVSS 106
- Parflex Division is third party certified for ISO 14001 and TS 16949
- 6mm Nylon, 5.5mm EPDM, and 4mm EPDM are IP6X, IPX8, and IPX9K Certified

## Tubing

### Construction

Tube: Nylon Air Brake Tubing

### Operating Parameters

Temperature Range: -40°F to +200°F (-40°C to +93°C)

Working Pressure: 150 psi (10.3 bar)

### Options

Each tube can be color-coded and/or numbered

Each harness may contain any number of tube sizes ranging from 1/8" O.D. to 3/4" O.D.

The harness can be supplied with special clamps, brackets and fittings to meet any need required by the customer

## Hose

Contact Parflex Customer Service for custom formed hoses and hose assemblies



### Cut Tubes

Any tube offered by Parflex can be cut-to-length, with options for additional marking



### Formed Tubes

Tubes can be formed into shapes for ease of installation

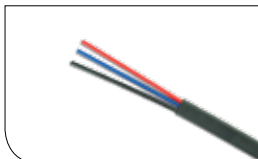

### Jacketed Bundles

Two or more tubes can be bundled together with an extruded thermoplastic jacket

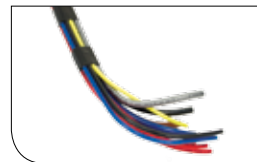

### Straight Harnesses

Combine multiple cut tubes into a harness built specifically for your application



### Formed Harnesses

Combine multiple formed tubes to create a repeatable tubing routing solution



### Formed Assemblies

Most Parflex thermoplastic hoses can be formed into application specific shapes

# SCR Hose Assemblies for Tier IV Compliance



## Features

- Consistent thaw - more reliable than coolant heated lines
- Multiple options available to fit every application
- Protective Overmolding
  - Protection against water ingress and damage of electrical components
  - Bolsters fitting strength and impact resistance
- Corrugated heat shield offers abrasion and heat resistance
- Assembled and designed in USA

## Certifications

- Parflex Division is third party certified for ISO 14001 and TS 16949
- 6mm Nylon, 5.5mm EPDM, and 4mm EPDM are IP6X, IPX8, and IPX9K Certified

## Applications/Markets



With Electrically Heated SCR Hose Assemblies from Parker's Parflex Division, a cleaner exhaust system means a cleaner environment. Designed for heating and conveying DEF (Diesel Exhaust Fluid) throughout the SCR system on commercial vehicles, Parflex hoses are made to handle both on-road and off-road applications while helping you stay Tier IV and EPA '10 compliant. Combine these hoses with other high value Parflex fluid conveyance products (pilot lines, grease lines, hydraulic hoses, etc.) so your customer can enjoy best in class durability and performance.

All Parflex SCR hose assemblies have multiple options that allow customization by the equipment manufacturer and the end user

SCR hoses are available with several different options. These include, but are not limited to: different electrical connectors, including options for heat and abrasion shield over lead wires; 1/4, 5/16, and 3/8 fittings; wide variety of lengths; 12V or 24V; etc. Parflex also has designs for other sizes and core tubes for SCR hoses. These designs ensure that Parflex hoses can be utilized on SCR systems from multiple suppliers.

U.S. Patent No. 8,819,922

Check [www.scrhose.com](http://www.scrhose.com) for product updates

For detailed ordering information, please consult price list or contact Parflex® Division.

Parker Hannifin Corporation | Parflex® Division | Ravenna, Ohio | [parker.com/pfd](http://parker.com/pfd)



D-13

## S0/S1/S2

Suction/Throttle Line Design



### Parflex SCR Hose Assembly Polyamide Suction/Throttle Line

- Thermoplastic core tube with fabric reinforcement
- Extruded thermoplastic jacket
- Optional heat/abrasion shield

### Certifications

- TS 16949
- ISO 14001

Base Part Number	Nominal I.D.		O.D.		with Shield (opt)		Max. Oper. Pressure		Min. Burst Pressure		Vacuum Resistance		Bend Radius		Standard Lengths*
	mm	inch	mm	inch	mm	inch	psi	bar	psi	bar	inch	Hg/bar	inch	mm	mtr
S0	6	.24	14	.55	21	.827	145	10	600	40	8.9	300m	2	51	1/2, 1, 1-1/2 or 2
S1	6	.24	14	.55	21	.827	145	10	600	40	8.9	300m	2	51	1/2, 1, 1-1/2 or 2

### Operating Parameters

- Temperature Range: -40°F to 158°F (-40°C to 70°C)  
Spikes to 221°F (105°C)
- Available in 12VDC or 24VDC design

Many custom options available, please contact Parflex for details.

S0 - No abrasion guard      S1 - Abrasion guard, hose only      S2 - Abrasion guard on hose and wire

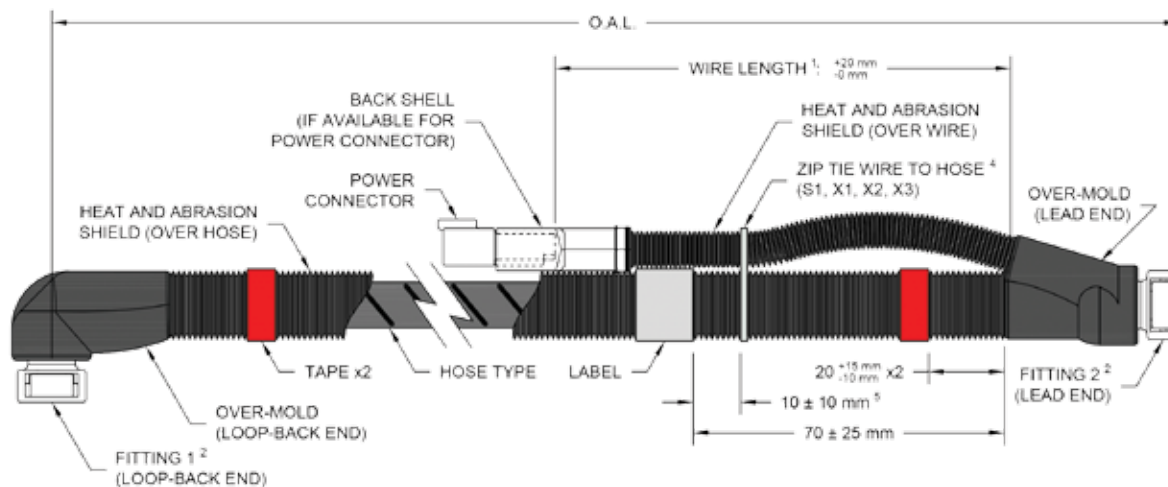

## P1/P2

Polyamide Pressure Line Design



### Parflex SCR Hose Assembly Polyamide Pressure Line

- Specialty high temperature polyamide
- core with fabric reinforcement
- Stainless steel heating wire
- Extruded high temperature thermoplastic jacket
- Heat/abrasion shield

### Operating Parameters

- Temperature Range: -40°F to 248°F (-40°C to 120°C)  
Spikes to 284°F (140°C)
- Internal/Fluid Temp: 140°F (60°C) Max., per Cummins AEB
- Available in 12VDC or 24VDC design

Base Part Number	I.D.		O.D.		with Shield (opt)		Max. Oper. Pressure		Min. Burst Pressure		Bend Radius		Standard Lengths*
	mm	inch	mm	inch	mm	inch	psi	bar	psi	bar	inch	mm	mtr
S0	6	.24	13	.51	21	.827	145	10	600	40	2	51	1/2, 1, 1.5, 2, 2.5, 3

Many custom options available, please contact Parflex for details.

P1 - Abrasion guard, hose only      P2 - Abrasion guard on hose and wire



For detailed ordering information, please consult price list or contact Parflex® Division.

Parker Hannifin Corporation | Parflex® Division | Ravenna, Ohio | [parker.com/pfd](http://parker.com/pfd)